

MVP® 2001

Table of Contents

System Overview	1
Summary of Features	2
Unpacking	3
Bench-Top Quick Start	3
MVP® Command Set	5
Supported DeviceNet™ Attributes	13
Status Response Bit Map	17
Front Panel Indicators & Configuration Options	18
Selecting an Operating Mode	20
Remote Mode	21
Real World Applications	29
Current Limit	30
Local Mode	32
DeviceNet™ Mode	33
Appendices:	
Appendix A: Kit Contents, Options, Pricing	34
Appendix B: Connection Diagrams	35
Appendix C: Troubleshooting	37
Appendix D: Frequently Asked Questions	38
Appendix E: External Connections	43
Appendix F: Applications Examples	45
Appendix G: Digital Filter Configuration	55
Appendix H: Linear or PWM Operation	59
Appendix I: Mounting	60
Appendix J: Micro Mo® MVP® 2001 Data Sheet	61
Appendix K: MVP® Warranty	63

DeviceNet™ Compliant Motion Control Systems

MVP®2001 Series

System Overview

For over 15 years MicroMo Electronics, Inc. has been committed to providing quality cost-effective solutions for motion control applications. The MVP®2001 Series of single axis motion control modules is MicroMo's response to the thousands of engineering professionals who have told us they wanted a economical, flexible, reliable, and easier to use motion control tool—one with full functionality, capable of supporting today's most demanding applications.

Since 1962, MicroMo Electronics, Inc., as the leader in coreless motor technology, has supplied fractional horse-power motors, drives, and controls to the medical, semiconductor, automation, instrumentation, military, aerospace, and special machinery markets, providing logical solutions for a wide range of complex applications requirements. MicroMo has packaged today's motion control solutions in the MVP™ 2001 DeviceNet™ compliant servo drive. Simple to use, reliable, powerful, and cost effective enough for the most demanding OEM integrations, the MVP™ 2001 can streamline your motion development efforts, allowing you to focus your engineering resources where they're needed most.

MVP® 2001 Series Controllers:

MVP™ 2001 can be operated in a local, stand-alone configuration, through downloaded macro routines, or under the control of a master computer or PLC as part of a distributed control system. This capability provides the systems designer with greater flexibility in allocating control resources, since repetitive, lower level operations can be handled independently. Motion operations are conducted completely “on the fly” providing seamless transition between moves and velocity or position control. Alternating between local and remote or host control may also occur at any time, and command control may be conducted simultaneously through the serial and DeviceNet™ interfaces if necessary. This flexibility permits the MVP® 2001 to fit seamlessly into virtually any system architecture and reduces integration and development costs. Example source code files for VB and LabView applications are available at no charge.

The MVP® (Motion, Velocity, Position) Series servo drives are provided in two standard configurations and can be customized to meet the needs of virtually any OEM configuration. The MVP2001A version contains a PWM drive amplifier supporting both PMDC and three phase brushless DC motors. The MVP2001B is supplied with a linear drive amplifier designed to extend the operating life of DC motors containing precious metal brushes. Both versions contain a myriad of standard features designed to support your most critical needs and are available with a Developer's Kit option that contains the essential elements required to operate the system immediately upon receipt. The Developer's Kits include the appropriate communications cable for RS232 or RS485, a 24V power supply, universal power supply cable, a potentiometer for local operation, an operator's manual, and demonstration software with examples you can run immediately.

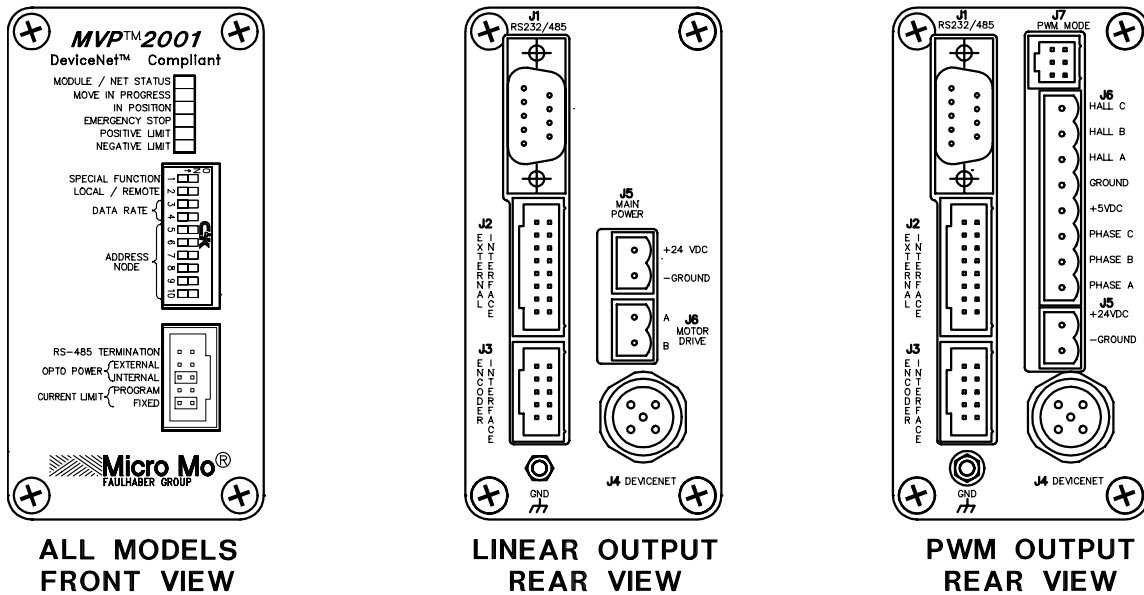

Figure 1

MVP® units can be operated as either stand-alone modules or as part of a distributed control system (DCS).

Summary of Features:

- Programmable Current Limit
- Fully Compliant DeviceNet™ Interface
- Optically Isolated Inputs Including Encoder, Overtravel Limits, External Event (Home) Inputs, and Emergency Stop
- One Analog Input (10 bit)
- One Analog Output (12 bit) Also used for programable current limit.
- +/- 10 Volt DC Linear and 0-100% and 50/50 PWM Control Outputs
- Linear Drive Amplifier Supplying 10 Watts Continuous @22°C Ambient, or
- PWM Drive Amplifier Supplying 50 Watts Continuous @22°C Ambient
- Programmable Position Range Limits
- Programmable Maximum Allowable Following Error
- RS-232C or RS-485 Operation May be Specified
- Panel, Rack, or Optional DIN Rail Mounting
- Stand-alone, Terminal, PC Compatible, or DeviceNet™ Operation
- Interface Software Demo and Example Code Included (with Developer's Kit)
- Very Compact—only 2x4x4 inches
- Easy to Use Plug and Play Operation
- Flexible Configuration Through Software Means Minimal Module Inventory

Communication, I/O, & Environmental:

RS-232C and RS-485 (Commands sent as ASCII), DeviceNet™ (CAN).

Controller Inputs:

- Encoder: Two channel, single-ended +5VDC TTL compatible
4 MHz max. frequency, optically isolated
- Analog: One analog input (0-5VDC, 10 bit)
- General Purpose: Two hard limits, one emergency stop, two external event inputs:
all optically protected

Controller Outputs:

Analog	One analog output (+/-10VDC, 12 bit DAC)
Motor Command	One 12-bit DAC (+/-10VDC), one 0-100% PWM, one 50/50 PWM output (for higher inductance applications)

Drive Amplifier:

Linear Amplifier	Outputs +/-22VDC @ 1.0 Amp continuous; 3.5 Amp peak
PWM Amplifier	24.6kHz switching frequency, 3 Amp continuous; 10 Amp peak @22°C (72°F)

Provisions are included for the addition of a larger external amplifier for driving large motors

Environmental (standard version):

Controller Operating Temp	0 to +70°C (32°F to 158°F)
Ambient Operating Temp	0 to +40°C (32°F to 104°F)
Storage Temp	-25°C to +85°C (-13°F to +185°F)
Humidity Tolerance	80% RH, non-condensing
Enclosure Protection Level	IP40

Unpacking

Examine shipping containers for visible damage. If damage is discovered, file a claim with the carrier immediately. Each MVP® 2001 controller has been 100% inspected and tested prior to shipment in accordance with MicroMo's ISO 9001 Quality Assurance Program. Your MVP® 2001 comes in an antistatic package. Carefully remove the unit from this package and retain the packaging in case the controller needs to be shipped or stored in the future. Make sure that the unit(s) shipped match the packing list. **WARNING: The MVP® contains ESD sensitive devices.**

Bench-top Quick Start

All MVP® modules are thoroughly tested at our Clearwater, FL USA facility before shipment. As damage can occur in transit, however, we recommend that you hook up your module and verify its operation upon receipt. This should only take about 5 minutes, and, for Developer's Kit versions, requires no other supplementary equipment or hardware. It is not necessary to install the Demo Software for this verification.

1. Make sure you have all the parts listed on the packing list.

2. Refer to the connection diagram appropriate for your particular system in Appendix B of this manual. **DO NOT APPLY POWER AT THIS TIME.**

3. Carefully plug motor, encoder, potentiometer, and power supply into the MVP® module noting the orientation of each pair of connectors. Power to the unit must be **off** at this point. **WARNING: Connecting the input power to the amplifier outputs can permanently damage the unit.**

While we recommend that you use the power supply cable with a lab-type power supply for full power simulations, the 24VDC wall-pluggable supply included in the Developer's Kit is adequate for demonstrating the basic operating modes and profiles possible with the MVP® system. We do not recommend using the wall sourced version for actual applications due to its limited current sourcing capabilities.

4. Set the DIP switches 1-10 as follows to activate Local Absolute Velocity Control
5. Put the “opto power” jumper on “Internal”. Make sure the “current limit” jumper is on “Fixed” mode.
6. Turn power to the MVP® unit on (24V). You should now have Absolute Velocity Control using the

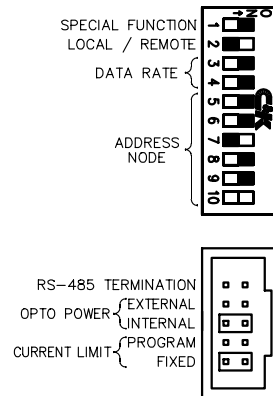

potentiometer. Try controlling the direction of the motor shaft by slowly turning the potentiometer one way, then the other. The null point is at the center of the knob’s range of travel. When you are in this (center) position the green “in position” LED will come on.

7. If the motor moves and responds to the potentiometer input signals, you are ready to begin developing your application. If the motor “runs away” or does not respond to the control input, it may be necessary to reverse the motor leads on the J6 connector with brush type motors. If problems persist, recheck items 1 through 6; then refer to Appendix C (Troubleshooting).

Planning your Application:

The most crucial element in a successful automation application is the initial planning phase. Careful analysis of the system requirements and dynamic interactions early in the development stage can prevent hours of frustration later.

Operation of the MVP® 2001 using macro routines or a host device provides the maximum functionality. Macros can provide functionality that ranges from simple free standing speed control to varied, complex, repetitive position sequences, including six high speed indexing modes. Host control in a distributed manner using RS232, RS485, or DeviceNet™ provides a convenient means to interface with multiple motion nodes and third party devices over extended distances and in harsh environments. When used in combination, these resources provide the performance of local processing with reliability and determinism, which are essential to complex automation integrations.

The next section details the Command Set for both interface choices. Detailed information regarding supported DeviceNet attributes is contained in Section 2 of this manual.

In serial communications mode, The MVP is controlled via a series of ASC II instructions issued by the Master computer or PLC. Multiple device nodes can be communicated with simultaneously by inserting a comma between the node addresses to be accessed. All nodes will also respond to a command issued to address 0. This function, when combined with the X parameter allows the digital filters of multiple nodes to be synchronized.

Motion Related Commands:

M (Move) Initiate Motion **4 M**

Receipt of the "M" Move command initiates motion using the values presently loaded to determine the profile characteristics.

LA Load Absolute Target Position **4 LA 10000**

Allows programming of the desired target position relative to the present zero or "home" position.

LR Load Relative Target Position **4 LR 10000**

Allows programming of the desired target position relative to the present position.

SP Load Maximum Commanded Velocity **4 SP 3000**

This parameter should be loaded with the desired maximum profile velocity. This value should be selected to not exceed the capabilities of the mechanical system. Velocity is specified as quadrature counts/sample period.

AC Load Profile Acceleration **4 AC 100**

This parameter determines the acceleration and deceleration rate to be calculated by the profiler during execution. Acceleration (AC) = (SP * 16) / (T / 1/SR)) T=Time to Accelerate, SP=Max Velocity, AC=Acceleration, and SR=Sample rate.

AS Report Actual Speed **4 AS**

This command queries the MVP for actual speed.

DC Load Profile Deceleration **4 DC 100**

This parameter determines the deceleration rate to be calculated by the profiler during execution.

V Constant Velocity Command **4 V 2200**

Execution of this command causes the controller to switch into the Velocity control mode. The motor will ramp the selected velocity at the rate defined by the AC parameter. Velocity mode can be used interactively with position mode.

DI Disable Drive **4 DI**

Execution of this command disables the drive electronics and removes all current from the motor. With the exception of Local Mode Operation, the MVP defaults to the disabled state on power up.

EN Enable Drive **4 EN**

This instruction enables the drive electronics and allows the servo controller to become active, providing motor current as required.

LL Set Position Range Limits **4 LL 2000000 or 4 LL -130000**

The range limit mechanism provides an additional layer of protection in applications where the network master calculates position data on the fly. Both positive and negative range limits are determined independently using the sign of the limit parameter. If the MVP receives an instruction from the host to move to a position which is not within the range limit window, it will respond as directed by the SA parameter.

SA Select Range Limit Action **4 SA 2 (Code = 0 - 2)**

The Range Limit Action Code determines the MVP response to a command directing motion outside of the defined range limits. Action code 0 disables the drive immediately. Setting the code to 1 causes the MVP to attempt to servo in the present position. If action code 2 is selected, the MVP will move to the programmed range limit position.

T Set Percentage Trajectory Parameter **4 T 45**

This parameter allows the user to determine the percentage of the profile to be completed prior to the Percent Complete Flag, (Status bit 4) being set. If this parameter is set to 0, the Percent Complete Flag will not become set during profile execution.

AB Abort Motion Command **4 AB**

Execution of this command terminates the present motion and the motor will ramp to a stop at the rate determined by the AD parameter.

AD Abort Deceleration Parameter **4 AD 200**

This parameter allows the user to define the abort deceleration rate. This capability permits a profile to be interrupted without loss of servo control by selecting abort action code 2, which is the power up default setting.

AA Abort Action Codes **4 AA 2**

The Abort Action Codes permit selection of the behavior of the controller during an abort situation. Action code 0 disables the drive immediately. Setting the code to 1 causes the MVP to perform a Hard Stop and attempt to servo in the present position. If action code 2 is selected, the MVP will abort the profile at the programmed abort deceleration rate.

HO Define the present position (Home) **4 HO (Argument optional)**

The HOME parameter provides a mechanism to define a known mechanical position a specific numerical position within the MVP controller's operational space. Using this command without an argument will set the position to 0. If an argument is used, the new position will be defined by the numerical value of the argument.

HA Arm the "HOME" input **4 HA 1**

The external event input on the J2 connector, pin 7 can be used as a "HOME" input that can be triggered by an external sensor or proximity switch. When used in conjunction with the HP command, an automated homing sequence can be easily implemented. Setting the HA parameter argument to 0 will disable the function. The input is also disarmed once it has been triggered. (Note: HA 2 configures J2-8 as the home input).

HP Define Home Arming Polarity **4 HP 0 (0 = Negative Logic)**

The HP command allows the user to select positive or negative logic input signals to trigger the HOME. This flexibility eases installation into existing applications where the state of these signals is predetermined. The Home operation is performed upon the appropriate change of state of the selected input.

LP Define Limit and Estop Polarity **4 LP 0 (0 = Negative Logic)**

The LP command allows the user to select positive or negative logic input signals to trigger the Error inputs. This flexibility eases installation into existing applications where the state of these signals is predetermined. The Error operation is performed upon the appropriate change of state of the selected input.

HS Query Home Arming Status **4 HS**

This allows the user to verify the status of the Homing Sequence. Bit 0 indicates the present status of the Arming function, and bit one reflects the current polarity setting. It is important to note that the polarity configuration affects only the event inputs.

HF Homing Sequence Action Code **4 HF 2**

Configuration of this parameter provided the user the opportunity to select which behavior the controller implements during the “Homing” process. Action code 0 disables the drive amplifier when the home input is triggered. Setting the code to 1 will cause the MVP to execute a “Hard Stop”, assigning the present position as the HOME position when the input is triggered, and code 2 is the selection required if a “Soft Stop” is desired. The deceleration rate is defined using the AD parameter.

FD Set Max Dynamic Following Error **4 FD 1000**

This parameter allows the user to limit the amount of following error in a profile to a predetermined maximum. Excess following error is treated as an exception as defined by the FA parameter.

FDT Set Following Error Delay **4 FDT 1000**

This parameter allows the user to set a delay before following error flag given that following error has occurred.

FA Configure Following Error Action **4 FA 2 (0 - 2)**

This parameter determines the action taken when the following error exception occurs. Action code 0 will disable the drive current. Action code 1 will cause the MVP to attempt to servo in the present position, and action code 2 causes the MVP to attempt to recover the accumulated error, but prevents any additional error accumulation.

LS Limit Sequence Enable **4 LS 1**

The limit sequence defines the controller’s response to the activation of one of the overtravel limit inputs. Setting the LS flag to 0 causes the MVP to disable the drive amplifier upon limit input activation. Setting the LS flag to 1 causes the MVP to permit motion only in the opposite direction until the activated input is cleared.

Parameters for Analog (Local) Control

O Local/Remote Mode Flag **4 O 0**

This flag provides a mechanism for the user to switch from remote mode to local velocity mode, which provides velocity control using the analog input voltage as the velocity command signal. When used in conjunction with the J parameter, this functionality provides a convenient means of switching from programmable to manual control. Setting O to a 0 selects remote mode, and setting o to a 1 selects local velocity control mode.

J Set Local Velocity Range Multiplier **4 J 2**

This parameter is used to allow the user to select the local mode speed range. Since the encoder resolution and the value of the command voltage multiplied by a scaling factor determine the velocity, the velocity ranges indicated are using a 500 ppr encoder.

0 = 250 rpm (default)

1 = 1000 rpm

2 = 5000 rpm

3 = 10000 rpm

4 = 20000 rpm

JM Select Joystick Mid Point **4 JM 512**

Setting this parameter permits the user to determine the MID point of the joystick analog input in order to mitigate any offset in the input signal. (Default = 512)

JW Select Joystick Center Window **4 JW 10**

Setting this parameter adjusts the size of the center zero position of the analog input command signal. (Default = 10)

JH Set Joystick Hysterisis Window **4 JH 1**

Setting this parameter permits the user to define the amount of hysteresis is applied to the analog control input value to eliminate the effects of noise on the input. (Default = 1)

K Select Continuous Integration **4 K 1**

Setting this parameter to 0 permits the user to disable the integral term of the digital filter.

N Define the “In Position” Range **4 N 1**

The value of the N parameter determines the size of the position window that the MVP considers to be “In Position”.

W Define the Open Loop PWM Duty **4 W 1000**

The value of the W parameter allows the user to define the open loop duty cycle of the PWM output. 0 through 2047 represent a 0 – 100 % duty cycle in a positive direction, while 4095 through 2048 is 0 – 100 % in the negative direction.

I/O Related Commands:

Serial I/O responses consist of the responding nodes address, followed by the ASC II representation of the requested data parameter. All numerical responses are provided in hexadecimal notation.

Example Status Response: 0004 000A

Note that the node address is separated from the data by a “space” character. The string is terminated with a carriage return (13) and line feed (10) characters.

POS Query Present Position **4 POS**

The selected MVP node will report the present position of the motor immediately upon receipt of this instruction. (32 bit signed response)

ST Query Present Node Status **4 ST**

The selected MVP node will report the present node status immediately upon receipt of this instruction.

Bit 15	Bit 14	Bit 13	Bit 12	Bit 11	Bit 10	Bit 9	Bit 8
N-Lim	Event2	P-Lim	Event1	Estop	Local	R-Lim	Disable
Bit 7	Bit 6	Bit 5	Bit 4	Bit 3	Bit 2	Bit 1	Bit 0
FD-Error	DNErr	DNet	%Done	AMN Mode	Mode	In-Pos	Moving

ANI Query Analog Input Value **4 ANI**

The selected MVP node will report the present value of the analog input immediately upon receipt of this instruction. (16 bit signed response)

DACA Control DACA **4 DACA 1**

The J2 pin 10 DACA output will be driven high (+5 V) or low (0 V) when this command is used.

This command should be used only with MVP units that have integrated PWM Amplifiers.

ANO Set Current Limit **4 ANO 2047**

The MVP has programmable current limit protection. Programming the desired value to the analog output sets the current level. Refer to the charts diagramming the output current levels for the corresponding output voltages. If the fixed current limit option is selected on the MVP front panel, the analog output is available for alternative application.

ANM Analog Input Mode

4 ANM 1

This command configures the MVP's analog input pin (J2-1) as either a digital input or analog input. Setting ANM to 1 configures the analog input as a digital input whose signal level is reported in the MVP's status mask bit 3.

VLIM Control Output Voltage Limit

4 VLIM 650 (6.5 volts)

This command sets the Maximum output voltage supplied to a DC motor.

This command should be used only with MVP units that have integrated Linear Amplifiers.

ERR Query for Actual Positional Error

4 ERR

The selected MVP node will respond with the present servo loop error value.

SD Set Serial Response Delay

4 SD 2

The selected MVP node will delay serial responses 500us for each SD unit specified.

OK Set Serial "OK" Response

4 OK 1

Activating this function causes the MVP to respond with "ok" upon successful receipt of a command. Setting this parameter to zero disables this function. (Default = 0)

CK Set CHECKSUM calculation Mode

4 CK 1

Activating this function causes the MVP to calculate checksums for all serial messages received and transmitted. Setting this parameter to zero disables this function. (Default = 0). All messages transmitted by the MVP will have appended a "#" and checksum byte.

EX: "0004 000A#8". All messages transmitted to the MVP while this mode is active should include the standard syntax plus the appended "#" and calculated checksum byte terminated by a carriage return.

The checksum is calculated by adding the absolute value of each character without a carry. The resulting eight-bit value is the checksum.

Configuration Related Commands:

POR Set Proportional Loop Gain

4 POR 20000 (4K-32K)

The proportional gain determines the systems proportional response to a given amount of positional error. Increasing this parameter provides a tighter and more dynamically responsive system.

I Set Integral Loop Gain

4 I 50 (1 - 32K)

Unlike the proportional gain, where the response remains constant if there is no change in error, the integral term continues to increase the effects of it's response until it becomes effective. This parameter determines the rate of change of this response.

DER Set the Derivative Loop Gain

4 DER -25000 (1K-32K)

The derivative gain balances the loop error compensation against the rate of change of the loop error. Adjusting this parameter may be necessary to achieve optimal stability when using larger motors with longer mechanical time constants.

AE Auto Enable on boot

4 AE 1

This command causes the MVP Enable/Home next time it boots (AE=1).

AV Auto Velocity on boot

4 AV 500

This command causes the MVP Enable next time it boots and run its motor at the given velocity.

RN Reset Node **4 RN**
This command causes the MVP to perform a power on reset operation.

RE Reverse Encoder Phasing **4 RE 1**
This parameter allows the encoder phasing to be reversed to facilitate closure of the control loop.

RD Reverse Operational Direction **4 RD 1**
Often the direction of rotation of the motor when provided a positive command position needs to be reversed. This parameter allows the user to reconfigure the system without the need to rewire the motor or encoder connections.

SR Set MVP Loop Sample Period **4 SR 500**
This command allows the user to program the sampling rate of the digital filter. Increased sample periods are useful in cases where a low-resolution feedback encoder is used or where very low velocities are desired.

PWM Set Minimum PWM Duty Cycle **4 PWM 10 (0-100%)**
This parameter permits the user to define the minimum PWM operating duty cycle. (Default = 1)

X Synchronize Nodes **0 X**
This parameter arms the synchronization sequence in multiple MVP devices. The process is triggered when the next global move (0 M) command is issued.

Flash EEprom Related commands:

EEPSAV Save all parameters in EEprom **4 EEPSAV**
This command allows saving of all current configuration parameters to EEprom. Please note that for the MVP to use the saved parameters, the EEBOOT command must be configured.

EEBOOT Use configuration from EEprom on Boot **4 EEBOOT 1 (0/1)**
This command when active (EEBOOT 1) tells the MVP to read all configuration parameters from EEprom next boot cycle.

EEADDR Write/Read EEprom memory address **4 EEADDR 1024 (read)**
4 EEADDR 1024,C (write)

This command performs write/read access to EEprom memory addresses. The first command shows the syntax for reading location 1024 in the EEprom. The second command shows the syntax for writing a “C” to location 1024 in EEprom. Please note that this command performs the Read/Write command automatically and Performs an automatic loading of EEdata as well.

EEDAT Data for EEprom **4 EEDAT**
This command holds the data from a previous read or current write command.

EEWR Write data to EEprom **4 EEWR**
This command executes a write to EEprom. EEdata and EEaddr should hold pertinent info.

EERD Read data from EEprom **4 EERD**
This command executes read from EEprom. EEdata and EEaddr should hold pertinent info.

Macro Related Commands:

ME Macro Execute **4 ME 1**
This command is used to execute a previously downloaded macro sequence.

MS Macro Status **4 MS**
This command is used to query the MVP for which Macro it is currently executing.
If the response is Zero, then it signifies that no macro is executing.

Indexing Commands:

ID Index Destination **4 ID 200000**
This parameter permits the user to configure the destination position for an indexing operation.

IS Indexing Velocity **4 IS 2000**
This parameter permits configuration of the indexing profile velocity.

IA Indexing Acceleration **4 IA 100**
This parameter permits configuration of the indexing profile acceleration.

IDC Indexing Deceleration **4 IDC 100**
This parameter permits configuration of the indexing profile deceleration.

IC Index Counts **4 IC 50 (0 - 65000)**
This parameter determines the number of limited cycles to be executed.

IO Index Destination (Final) **4 IO 100000**
This is the final move destination following index cycle completion.

IE Indexing Enable **4 IE 1**
The IE command provides a means of activating and deactivating indexing mode. Setting this flag to 1 activates indexing, and setting the flag to 0 restores normal operation.

IM Single/Limited/Continuous Indexing **4 IM (X)**

Single Operation **4 IM 0**
Indexing operation in single step absolute mode in response to an external pulse applied to J2, pin 8, or the invocation of the ITR serial index trigger command.

Continuous Operation **4 IM 1**
Indexing operation in continuous absolute mode in response to an external pulse applied to J2, pin 8, or the invocation of the ITR serial index trigger command.

Limited Operation **4 IM 2**
Indexing operation for a specified number of absolute cycles in response to an external pulse applied to J2, pin 8, or the invocation of the ITR serial index trigger command.

Single Operation **4 IM 3**
Indexing operation in single step relative mode in response to an external pulse applied to J2, pin 8, or the invocation of the ITR serial index trigger command.

Continuous Operation

4 IM 4

Indexing operation in continuous relative mode in response to an external pulse applied to J2, pin 8, or the invocation of the ITR serial index trigger command.

Limited Operation

4 IM 5

Indexing operation for a specified number of relative cycles in response to an external pulse applied to J2, pin 8, or the invocation of the ITR serial index trigger command.

ITR Index Serial Trigger

4 ITR

This command triggers an indexing operation via the serial interface.

ITD Index Destination Delay

4 ITD 2000

This parameter allows the user to determine the dwell time at the index destination position. Each unit is equal to a 500us-time delay.

ITZ Index Zero Delay

4 ITZ 2000

This parameter allows the user to determine the dwell time at the index zero position. Each unit is equal to a 500us-time delay.

Position Capture Commands:

CA Capture A Input

4 CA 1

Setting the input capture flag enables capture operations on external event input #1, (J2-7). Setting the flag to 0 terminates capture operation. This function is automatically cleared when the selected capture input is triggered.

POSCA Report Capture Position A

4 POSCA

This command causes the MVP to return the position captured when capture input A (J2-7) was last triggered.

CB Capture B Input

4 CB 1

Setting the input capture flag enables capture operations on external event input #2, (J2-8). Setting the flag to 0 terminates capture operation. This function is automatically cleared when the selected capture input is triggered.

POSCB Report Capture Position B

4 POSCB

This command causes the MVP to return the position captured when capture input B (J2-8) was last triggered.

Demo Software Command File Conventions:

ST mask>label

4 ST 10>mainloop 9>loop2

Adding a label name to the mask parameter (separated with a >) provides a means of implementing a logical goto operation for structured control. If the MVP system status matches a mask, a jump to the appropriate label will be performed.

Delay Timing Delay Function

Delay 100

This command causes the demo program to pause for the specified time period. Each unit represents a 10-millisecond delay.

Repeat Repeat Command

Repeat 4 repeat 4 times

The command allows a portion of the command file instructions to be repeated a number of times. The command **REND** must be used when the **REPEAT** command is invoked. Please note also that the repeat count can be used

inside the loop.

The arithmetic operators possible are: add (+),subtract (-),multiply (*),and divide (%)

Repeat Repeat End **Repeat**

This command marks where the Repeat code stops.

Repeat Examples:

Example #1

```
4 HO
4 EN
REPEAT 4                                /* the code below will be executed 4 times */
4 LA 10000
4 M
4 ST 10
4 LA 0
4 M
4 ST 10
REND
```

Example #2

```
4 HO
4 EN
REPEAT 4                                /* the code below will be executed 4 times */
4 LA 1000* REPEAT                    /* additionally, the LA destination will change from 1000 4 M
                                         /* to 2000, 3000 and finally 4000 since it uses the
4 ST 10                                /* REPEAT count as a Multiplier
4 LA 0
4 M
4 ST 10
REND
```

```
/* */                                Comment Fields                                4 HO /* Main Loop*/
```

The slash asterisk allows comments to be inserted into command files.

Supported DeviceNet™ Attributes

Command Messages:

- Command Message Type 01 hex Target Position
- Command Message Type 02 hex Target Velocity
- Command Message Type 03 hex Target Acceleration
- Command Message Type 04 hex Target Deceleration
- Command Message Type 05 hex Target Torque
- Command Message Type 1A hex Position Controller Supervisor
- Command Message Type 1B hex Position Controller
- Command Message Type 1C hex Block Sequencer
- Command Message Type 1E hex Command Block
- Command Message Type 1F hex Parameter

Response Messages:

Response Message Type 01 hex Actual Position
Response Message Type 02 hex Command Position
Response Message Type 03 hex Actual Velocity
Response Message Type 04 hex Command Velocity
Response Message Type 05 hex Torque
Response Message Type 06 hex Captured Home Position
Response Message Type 07 hex Captured Index Position
Response Message Type 14 hex Command/Response Error
Response Message Type 1A hex Position Controller Supervisor
Response Message Type 1B hex Position Controller
Response Message Type 1C hex Block Sequencer
Response Message Type 1E hex Command Block
Response Message Type 1F hex Parameter

Position Controller Supervisor Object Instance Attributes Class = 24

1	Number of attributes in this class
2	List of supported attribute ID's
3	Axis number
5	General Fault
6	Command Type
7	Response Type
10	Home Action
11	Home Active Level
12	Home Arm
16	Home Input Level

Position Controller Object Instance Attributes Class = 25

1	Number of attributes in this class
2	List of supported attribute ID's
3	Mode
6	Target Position
7	Target Velocity
8	Acceleration
9	Deceleration
10	Incremental Position Flag
11	Load Data/Profile Handshake
12	On Target Position
13	Actual Position
14	Actual Velocity
15	Commanded Position
16	Commanded Velocity
17	Enable
20	Smooth Stop
21	Hard Stop

23	Direction
30	Kp
31	Ki
32	Kd
37	Sample Rate
38	Position Deadband
45	Maximum Dynamic Following Error
46	Following Error Action
47	Actual Following Error
53	Soft Limit Action
54	Positive Soft Limit Position
55	Negative Soft Limit Position
56	Positive Limit Triggered
57	Negative Limit Triggered
58	Load Data Complete

Block Sequencer Object Instance Attributes Class = 26

1	Instance Number of starting Command Block
2	Block Execution flag
3	Current Block in Execution
4	Block Fault Flag

Polled vs. Explicit Messaging on DeviceNet:

Although the polled and explicit messaging connections are not the only types of connections, which can be implemented under the DeviceNet protocol, they are the most widely used during normal operation of the network. Broadcast messages such as those associated with the bit strobe connection do provide a certain amount of utility, but are limited to a particular, predefined functionality.

The polled messaging connection involves a data exchange between the master device and its allocated slave devices on a regular, cyclic scan interval. In this case, the master scanner reserves memory space for input and output data for each slave device it is to control. The programmer can command the slave devices by manipulating the output data using the appropriate command assemblies. This mechanism provides the system level programmer access to status response information for each slave node without the need for additional messaging. This is especially useful in applications where real time information is needed to provide current information to an operator display. Once all of the slave devices have been included in the scan list and the scanner has been brought on line, the user's application need only manipulate the scanner memory data to effect results.

The explicit messaging connection operates exclusively in a peer-to-peer manner. The master device will contact a slave directly to send to or receive data from the slave device as necessary. The timing and control of these messages lies solely with the user's application. In this case, the application must supply all of the information necessary to identify the target device within the message construction.

Status Response Bit Map:

The MVP® provides you with 16 status bits when you monitor or request the system's status. This feature cannot be used in DeviceNet™ Mode. They are read from right to left with the following values and meanings:

- Bit 0: 1=move in progress
0=not commanded to move
 - Bit 1: 1=motor is in position
0=motor is not in position
 - Bit 2: 1=MVP® is in Velocity Mode
0=MVP® is in Position Mode
 - Bit 3: This bit indicates the logic state of the analog input when ANM mode 1 is selected.
If ANM mode = 0, this bit will always be set to 1.
 - Bit 4: 1=Indicates trajectory percentage defined by the "T" command is complete
0=Trajectory complete percentage not yet achieved
 - Bit 5: 1=DeviceNet™ Connection Active
0=DeviceNet™ Connection Not Active
 - Bit 6: 1=a DeviceNet™ message error has occurred in one or more packets
0=the DeviceNet™ message packets are o.k.
 - Bit 7: 1=the current move is off its program trajectory by more than the allowed amount
(which is set by the FD command)
0=current move is going o.k.
 - Bit 8: 1=motor is not enabled or has been disabled by some other error
0=motor is enabled
 - Bit 9: 1=you have reached the program range limit (set by the LL command)
0=move is within the range limits
 - Bit 10: 1=Local Mode is active
0=Remote Mode is active
 - Bit 11: Emergency stop flag (1=active)
 - Bit 12: External Event #1 (1=active)
 - Bit 13: Positive Limit Flag (1=active)
 - Bit 14: External Event #2 (1=active)
 - Bit 15: Negative Limit Flag (1=active)
- } These flags signal the status
of input events

Input Events: The MVP® controller is capable of reacting to, and on, external events which you provide to it as inputs. The inputs can be used for any particular event you define. The event sets a bit in the status bit indicator only; for example, using a "home" sensor to turn the motor on or off depending on the position of a mechanism.

Positive and Negative hard limits are also recognized by the MVP®. These are typically error inputs. For example, one could use these inputs to stop a motor if an encoder were broken or if the encoder wires became damaged or disconnected. The hard limits are designed to remedy errors or alert the operator to events that are not planned or scheduled to occur.

Remember that **the configurations switches must be set unless the EEBoot function is active before powering up the unit, If the unit is operated in Local Mode, switches 3-10 may be changed “on the fly” (i.e. without resetting power to the module).**

RS-485 Network Termination: The termination jumper pins are at the bottom of the front mounted switches these provide end of line termination for the 485 network (see drawing below):

Unless you have specified otherwise, your MVP® unit has been shipped without a termination jumper installed. In the event you were to use a jumper (typically for very lengthy runs of networked modules), it is advisable to insert the jumper on the MVP® module furthest from the host controller. This keeps the signal levels balanced across the network. Each MVP® 2001 controller has an internal 120 Ohm termination resistor included for this purpose.

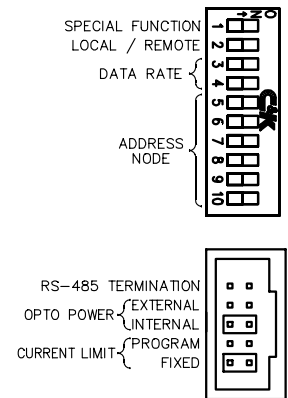

Amplifiers: One of the distinguishing features of the MVP® modular system is that integrated amplifiers are included inside each module. Your module is labeled in one of two ways. The MVP® 2001A contains a PWM amplifier which can be configured for 0-100% duty cycle (for low induction coreless DC motors) or 50-50% duty cycle (for higher inductance iron core motors). See Appendix H for more information on PWM mode selection. The PWM version is also used to drive and control Brushless DC motors. Using the drawing below, make sure your MVP® module is configured for the operating mode you want to use. One set of jumpers is included with each PWM module.

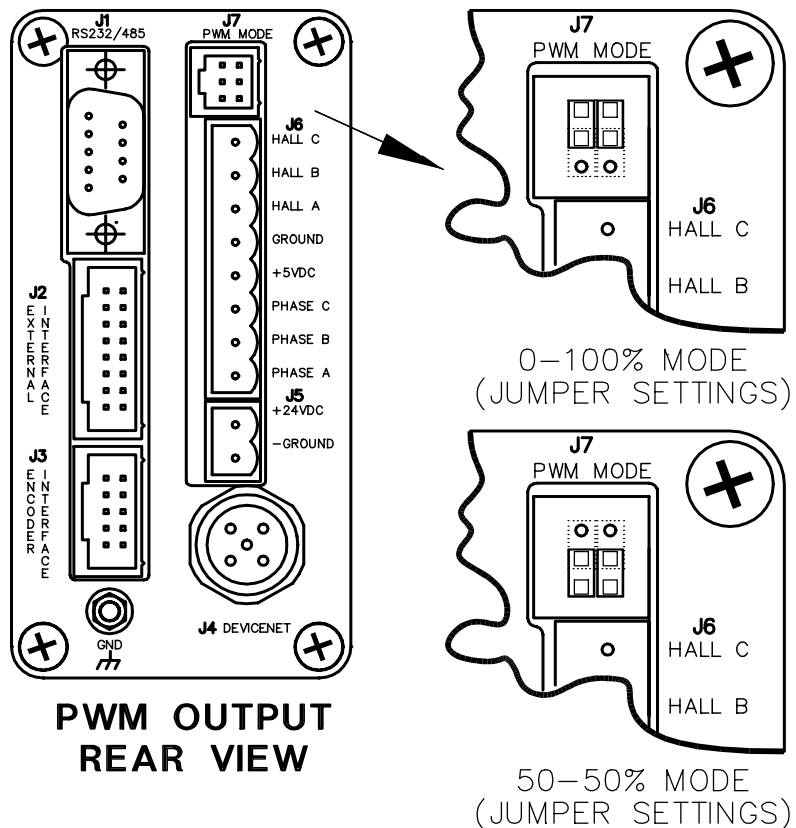

Selecting an Operating Mode:

There are two operating modes available for both the PWM and linear versions of the MVP®: Remote and Local. The DeviceNet™ protocol is always active. **Remote Mode** (position and/or velocity control) is appropriate when an external digital device such as a computer or host controller will be running your motion profile programs. **Local Mode** is appropriate when you want to control velocity or position with an analog input such as a potentiometer or external encoder. **DeviceNet™ Mode** (another way of accessing Remote Mode) is used when you integrate the MVP® into a DeviceNet™ compliant network control scheme. DeviceNet™ is automatically enabled upon receipt of a power up.

Stand-alone: This is the **Local Mode** option which is designed to operate as a free-standing module. Consequently, it needs no host connections or software installation. It is controlled solely by an analog input signal such as a potentiometer. In Local Mode, the MVP® can operate in **Velocity Control** (to command a desired motor velocity) or in **Position Control** (to track an external encoder signal). In **Velocity Control** the unit can be run in either **Absolute Mode** (for coarse speed control) or **Relative Mode** (for fine tuning the velocity). A controller configured for Local Mode Velocity Control can run on power-up at the same speed every time. Optional position tracking mode allows the MVP® to perform electronic gearing or use step/direction signals from a stepping motor controller.

In **Absolute Velocity Control (Switch 4 = ON)**, the motor shaft velocity is the value read from the analog input or potentiometer multiplied by the range selected with switches 7 through 10. **Switching between ranges is allowed at any time.** The new range will become effective during the next filter sample. This mode allows you to select a coarse velocity value before fine tuning.

In **Relative Velocity Control (Switch 4 = OFF)**, the motor shaft velocity is calculated in the same manner as in Absolute Velocity Control above. The difference in this operating mode is that once a velocity close to the desired velocity is achieved, in absolute mode, switching to relative mode and selecting a lower range on the fly will allow you to “tune” the final velocity to precisely your desired value.

Local Mode Control Loop (Gain) Configuration: Switches 5 and 6 allow you to select four different proportional gain values. The gain selected is determined by the binary encoding of these switches. Switch 5 is the least significant bit. The lowest gain is enabled with **both** switches (5 and 6) = **On**. The highest gain is selected with **both** switches (5 and 6) = **Off**. The operational mode as well as the gain configuration is determined at power-up.

DCS (Distributed Control System): The same MVP® module as above can also be configured to operate as a node on a computer or host controlled system. This can be accomplished through **Remote Mode** or **DeviceNet™ Mode** operation. In **Remote Mode** the MVP® module can perform trapezoidal motion profiles via an RS-232C or RS-485 serial connection to a host device such as a personal computer. With an RS-232C connection, one module (only) can be controlled from your serial port. With an RS-485 connection, up to 63 modules can be individually addressed and separately controlled. RS-485 port adapters are available from MicroMo if you choose to use this option. In both configurations the data format is 8 bits, no parity, and 1 stop bit. Xon/Xoff handshaking is not supported.

DeviceNet™ Mode: In this mode, the DeviceNet™ protocol is followed. In this operating mode, the MVP® is a Position Controller Object (device type 10 hex). Refer to page 10 for more information regarding DeviceNet™ Mode Operation. DeviceNet™ is automatically enabled and will respond to a DeviceNet™ message.

In **DeviceNet™ Mode** functionality is defined by the CAN-based communications protocol known as **DeviceNet™** which is accessed via a single connector on the rear of any MVP® module. In this mode, both **Velocity Control** and **Position Control** are available to you. All MVP® modules are fully DeviceNet™ compliant having been certified at the University of Michigan’s ODVA Compliance Test Laboratory.

It is important to note that RS-232C or RS-485 configuration is set internally at the factory. You must specify a specific serial operating mode when you order (except for DeviceNet™ applications which do not utilize a serial port). Also keep in mind that RS-232C cables and RS-485 cables cannot be interchanged even though both may fit your serial port.

Remote Mode: Remote operating mode allows closed loop speed and position control with trapezoidal profiling via the RS-232C or RS-485 interface. Remember when you operate in any of the serial modes, the communication protocol is pre-set at the factory to either RS-232C or RS-485. The format is always 8 data bits, no parity, and 1 stop bit. Confirm which model you have by checking the label on the side of the MVP® module. If your unit is configured for RS-485 operation, your host computer or terminal must also be capable of 485 communication. RS-485 converter modules are available from MicroMo. Inputs for analog control or monitoring, overtravel, emergency stop, and HOME or event sensing are also accessible. An amplifier enable output can also be used to automatically select an external amplifier when a control mode is activated. The overtravel inputs are intended to protect the drive from a hard stop and require manual intervention to recover. The status of the HOME or event inputs may be determined by testing bits in the status response. The value of the 10 bit analog input can be obtained by interrogating the controller using the serial ANI command. The location of the external interface connections are detailed in Appendix E.

Software Installation:

Operation in Remote Mode allows you to install the demo software which came with your Developer’s Kit or as an option with your first commercial shipment of MVP® modules. The demo software is designed to highlight the capabilities of Remote Mode Operation. The program disks are for Windows 3.x, Windows 95, or Windows NT operating systems, utilizing a 16550 UART or equivalent on a 486/66 MHz machine or better. To protect your system from viruses, all outgoing MVP® demo disks are scanned with anti-virus software. Initial program installation will give you an MVPDEMO icon in the program group on your hard drive which you can use for future training or testing. When installing the Windows program for the first time, close all other Windows programs. Insert disk 1 and run “a:\setup” (or “b:\setup” depending on where your floppy disk drive is located). Insert Disk 2 when prompted. This will establish an MVPDEMO icon in your program file group folder.

Remote Mode: Position Control

Remove power from the unit.

To set the unit up for Remote Position Control, set the configuration switches as follows before you power up the module:

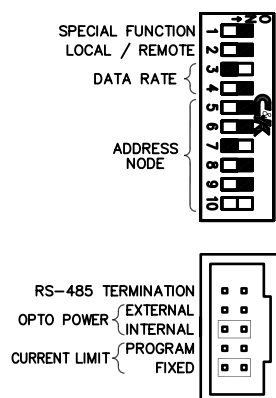

Next power up the module to load the configuration settings. Click on the MVP DEMO 2000 icon to begin setting up your system.

The default screen which you will open looks like this:

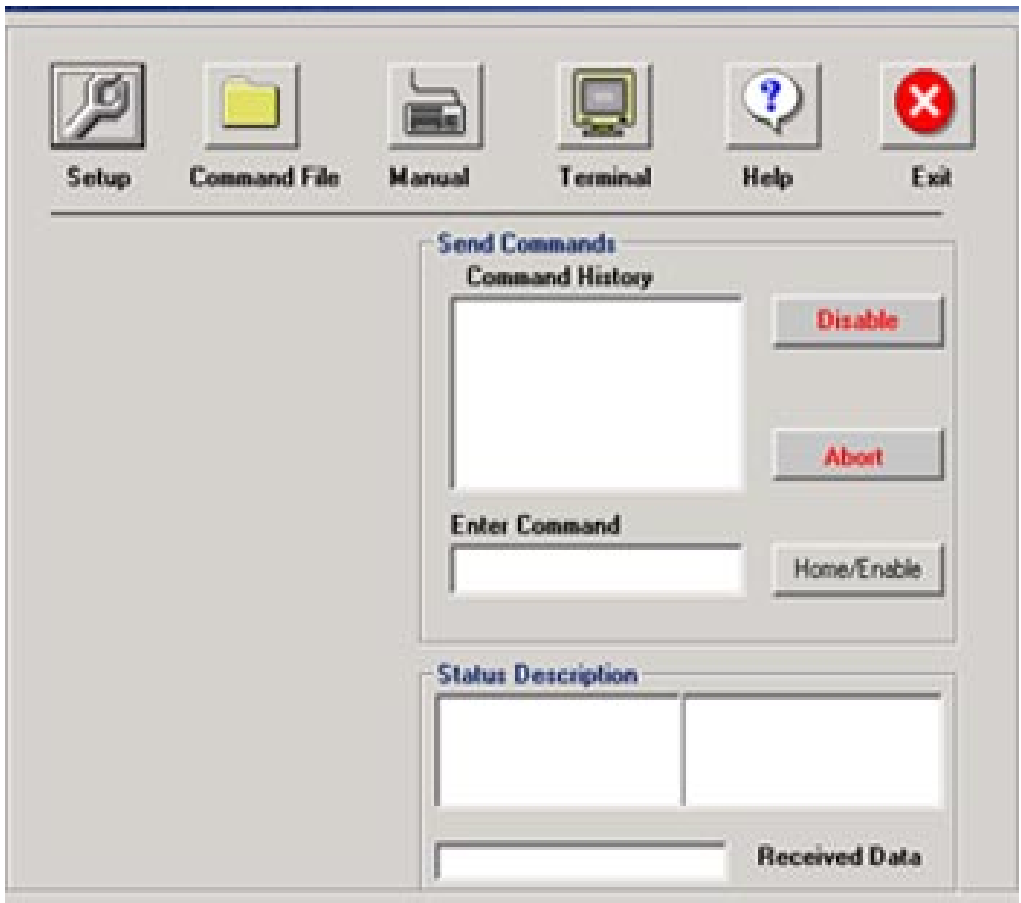

The setup button allows you to choose the baud rate at which your system will operate and the Comm port which you want to use. **Both the software and the MVP® module(s) running on this program must have the same baud rate.** We recommend configuring to 38,400 baud to provide reasonable bandwidth and information processing speed. options for configuring the status description and response data format are also available.

Switch Number		Remote Data Rate (kbaud)	
3	4	RS232-C/RS485	DeviceNet™
OFF	OFF	57.6	125
ON	OFF	19.2	250
OFF	ON	38.4	500
ON	ON	9.6	125

Select the “” Command file” button. The following screen (on the next page) will appear.

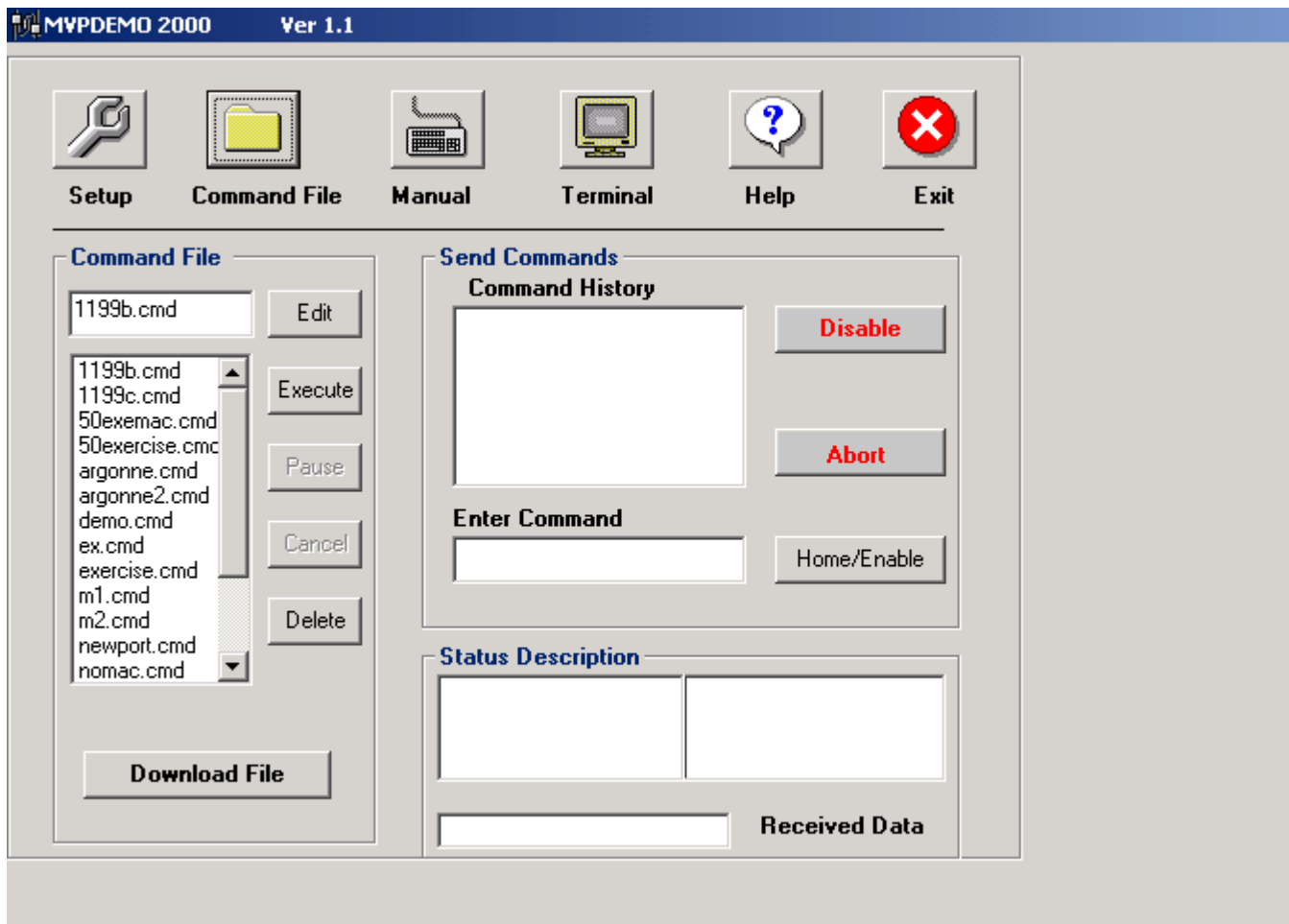

The sample code you will put into the “enter command” screen is only for exercises you will run. It can’t be saved and each instruction is invoked only once before passing into Command History. It will, however, give you a flavor of how the command structure works and will allow you to control a servo motor’s position and velocity. But first you will need to know a few generic motion command formalities.

1. A motor moves from a known location. This location from which it starts its initial move is called “home”. When the motor knows where its “home” is, you can make it go anywhere within the limits of the system, and then on to new locations or back to its original position. “Home” is identified by the abbreviated Command **HO**, or **home**—both will work.

2. Before a motor can move, it must be “enabled.” Enabling allows the MVP® to source current by turning on its amplifier. To “enable” your drive, you will use the Command **EN**.

3. In order for a module or series of modules to receive instructions from the host, each module must have a unique “address.” If you are using an RS-232C protocol, you will be using only one address, because in RS-232C configuration you can only communicate with one MVP® module. If you are using the RS-485 option, you must give each of your MVP® modules a unique address from 1-63 so each module will know when the host is addressing it. Using the address “0” will address all the modules in your network, except in DeviceNet™ Mode.

Node addresses are selected using switches 5-10 on the front of the unit. The addresses are encoded in binary format with switch 5 as the least significant bit. In this scheme, each switch has a numeric value as indicated below.

Switch Number	Value
5	1
6	2
7	4
8	8
9	16
10	32

To select an address, turn off the switches who's values add up to the desired address.

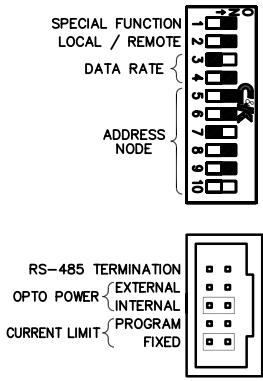

Practicing a Simple Sequence: Constructing a motion profile is simply a matter of stringing together a series of compatible commands which make the drive system execute the profile you want to implement. In the following examples we assume that your MVP® module has an address of 4. Try the following simple sequence to make the motor move, **after** first setting the MVP® to Remote Mode, setting baud rate to 38,400 baud , selecting an available comm port, and making sure that the address of your unit is 4. Whether the MVP® operates in Velocity Control or Position Control is command dependent (versus being set by changing the DIP switches). Here's what your DIP switches should look like:

1. Home: A motor's home location will be at a point you define as zero (0). To tell your module number 4 that it is home, enter "4 home" (without the quotes) and hit return.
2. Next, Enable your MVP® because you cannot move a motor that is not enabled. The EN command allows the amplifier to respond to commands destined for the MVP® module. Enter "4 en" and return.
3. Normally, you would next Set Proportional & Integral Gain, but for this exercise you can leave the gain settings in the default positions which are very tame. The Proportional Gain Setting defines how quickly your system will respond to a deviation from the desired profile (moving). The Integral Gain determines how fast the motor or load integrates into position at the end of the profile (stopped). When you do an actual motion application, you will have to change these values to optimize the performance of your system. If you need to brush up on this topic, see Appendix G: "Digital Filter Configuration."

4. Prepare to Make Your Move! To do this you will need to know the following:

a. The destination position (where the motor/load will move to). This can be either an Absolute or Relative point. If you want to move your load, motor shaft, etc. to a predetermined point from “home,” you will need to “load [the] absolute [destination position]” which you can do by giving the module(s) the command LA. Putting “4 la” followed by a space and a number less than +/- 2 billion (the range limit) will allow the shaft to turn up to the selected distance in either direction. If you want to go to a position a given distance from the point you are presently located at (other than home), give the module the command LR which will move the motor shaft incrementally relative to its present location (*i.e.* from a point other than home). Repeatedly typing “4 LR 50000”, followed by “M” to initiate the motion, should give you an idea if your motor is moving smoothly.

Don’t expect to achieve ranges of performance beyond the capabilities of the range limits (+ and -), of the system.

b. The velocity at which you wish to move. This is defined by the command SP (speed). The speed at which the motor shaft will turn is dependent on the resolution of the encoder you are using (see table below). If you are using a 500 cpr encoder, each unit = 1.0 rpm. If you were using a 10 cpr encoder, each unit = 50 rpm. Typing “4 sp 1000” (then enter) should be adequate for demonstration purposes.

Encoder Resolution	Quadrature	rpm/unit	Example
1000	4000	.50	2000/4000 = .50 rpm/step
500	2000	1.0	2000/2000 = 1.0 rpm/step
200	800	2.5	2000/800 = 2.5 rpm/step
100	400	5.0	2000/400 = 5.0 rpm/step
16	64	31.25	2000/64 = 31.2 rpm/step
15	60	33.33	2000/60 = 33.3 rpm/step
10	40	50.0	2000/40 = 50.0 rpm/step

* NOTE: using at 500 μ s sampling period

c. The acceleration (command AC) which is the number of quadrature counts per sample period. The sample period for the MVP® is 500 μ s. Try “4 ac 100” (enter) for starters.

5. Insert a “status” command. The status of your operations can be determined at any point in time by invoking the “status” command (represented as ST). You can enter any command you wish, without an argument, to verify the current setting. [No argument] is treated as a request to send the stored value back to the Host or Master. The ST command, for example, serves to verify that the move is happening or has happened. This is a very useful feature which avoids starting a move before the previous move has been completed. Try typing “4 st 10” to confirm your move. 10 (binary 1010) according to the status bit code, signified “command recognized,” “motor in position,” and “no other errors or exceptions”

6. Make it move by using the command “4 M” (MVP® box at address node #4 MOVE!). If your motor doesn’t move, recheck all connections and try reentering the command string again as follows:

```
4 home
4 en
4 la 500000
4 sp 4000
4 ac 100
4 st 10 [“command accepted”, motor in position]
4 M
```

If your motor does not move after reentering this string, try running the stored command files in the “Command File Processing” screen below. If that does not work, please consult the “Troubleshooting” guidelines in Appendix C.

Building a Command File: In order to construct, store, edit, and execute a simulated program, you must go into the editing screen by selecting the “Edit” button from the Mode Selection box.

Write a stored, executable file by clicking the edit button. An example is provided for you in the file called “demo.cmd.” The example is provided only to show you how the motor moves. Execute the sample program by highlighting the “demo.cmd” file and instruct it to run continuously. This will provide a working demo which will loop continuously until you “Cancel.”

Remote Velocity Control: Remote Velocity Control affords you the opportunity to control a motor’s velocity. The DIP switch settings are the same as for the Remote Position Control (above). Velocity instructions can be interspersed with position commands via the instruction set. Velocity commands can be set on the fly using the form:

[node#] v [number]

As an example: “4 v 100” Mixed mode moves are common in motion control applications. An example of mixed mode operation is included in Applications Examples (Appendix F).

Terminal Emulation

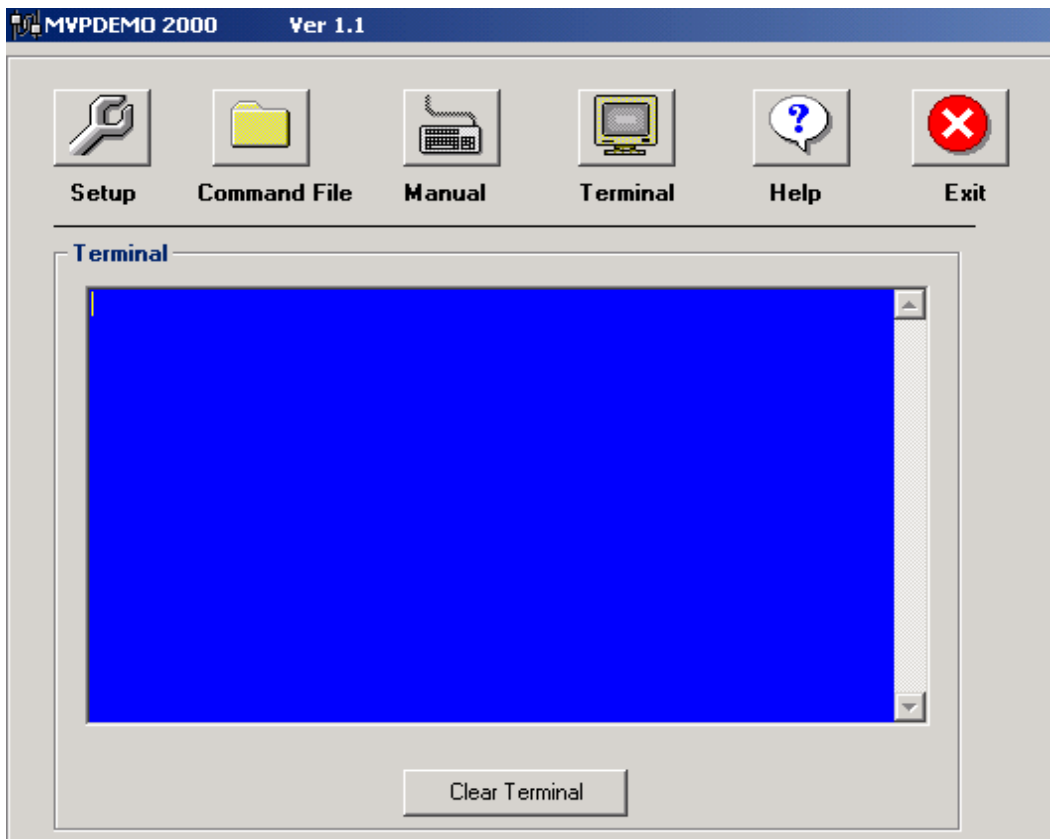

Terminal Emulation mode allows direct interaction with the MVP® 2001Controller. Command strings entered in terminal mode are sent directly to the target controller and response data is displayed in the terminal window. Configuration for terminal mode is the same as for all other modes. This provides a means to troubleshoot communications difficulties without the overhead of additional software.

Macro Operation

The Macro programming functionality provides the stand-alone capabilities of the MVP Series Controllers. In this configuration, programs developed using the MVP Demo Software can be downloaded into non-volatile memory contained within an MVP Servo Drive. A single Macro Module is capable of controlling up to 63 axis of MVP nodes. In addition to the ability to download multiple macro routines, individual macros may be “chained” together in any order providing additional flexibility. These “chained” groups of macro’s are called Macro Combinations. Once downloaded, macro routines may be activated at power up, serially, or through a DeviceNet connection. Macro routines provide a mechanism to implement configuration sequences, indexing operations, or variable motion profiles with minimal host interaction. Macro’s are usually developed and tested as command files and then downloaded once proper operation has been verified

Download Operation:

Once a command file has been developed and tested, press the download Dutton located on the bottom of the main demo window. The following download menu will appear and includes a list of available command files to select from.

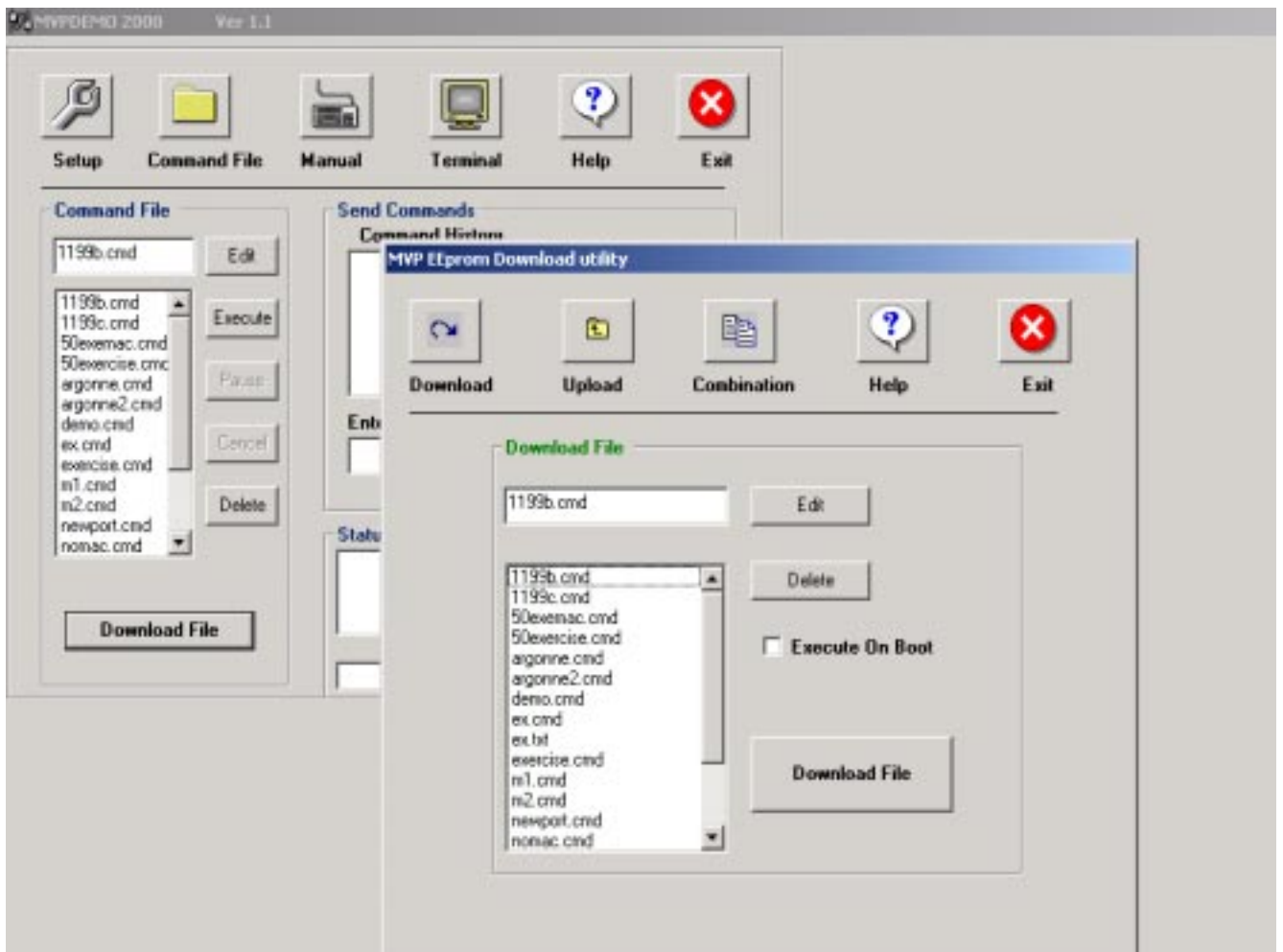

To download a single file, simply select the appropriate file and press the download button. If multiple macro routines are required, press the combination button to create a custom configuration.

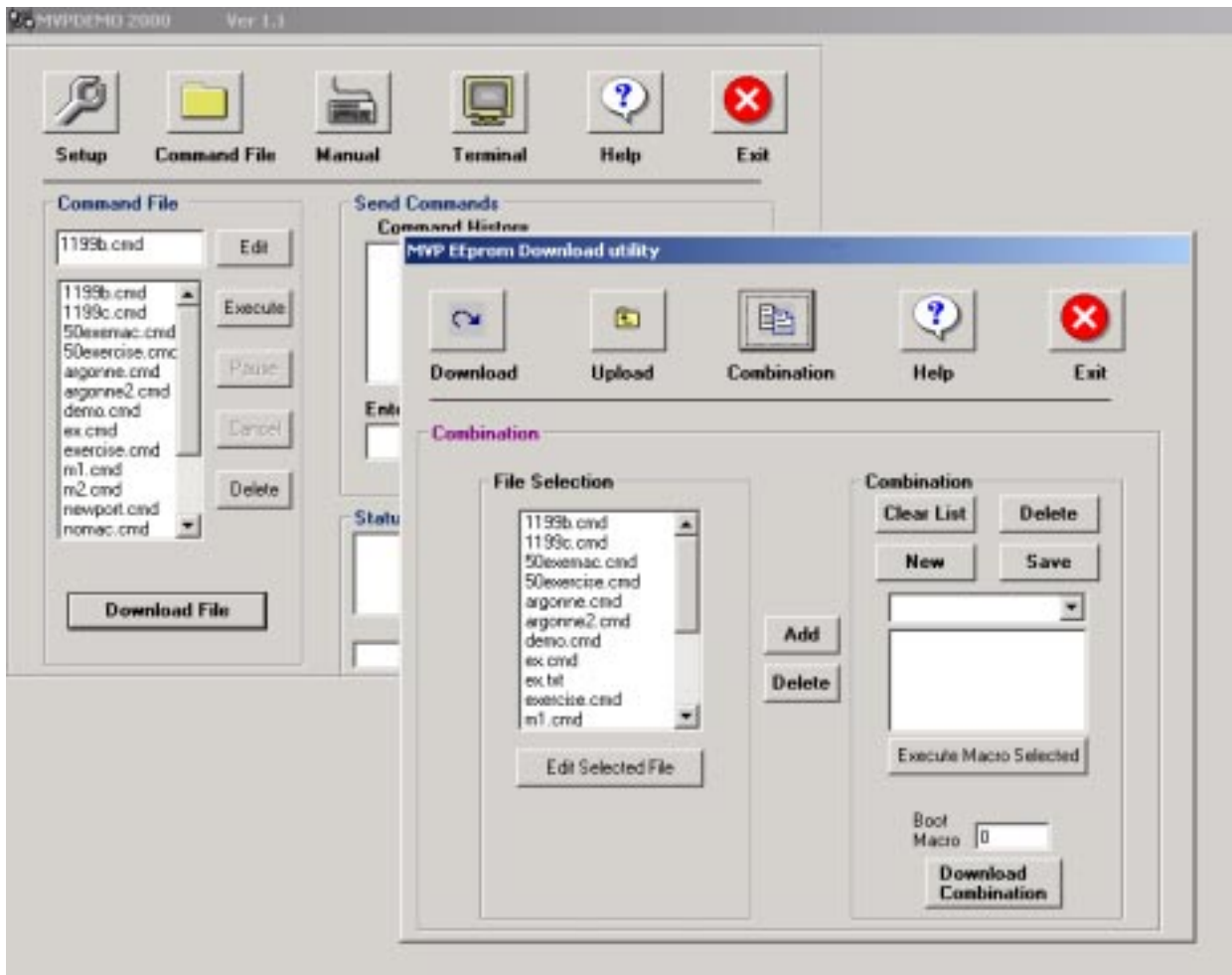

Select the files to be included in the combination and “add” them to the combination list. While no specific order is required for macro operation, it is a good practice to list the macros in order of execution. Once the list is complete, select the macro to be executed at power up in the “boot macro” window located in the lower right hand corner. If no power up macro is desired, enter 0 in this window. Press the “Download” button to return to the previous screen and press “Download”.

After the download process is complete, the macro routines are available for use. .

Real World Applications:

The **MVP Servo** Controllers are designed to be slave devices which are controlled by a Host or Master device. In the Remote operating mode, the **MVP** will not transmit on the communications interface except on power-up, unless it is instructed to do so by the Master device. The type of master device you select will depend on your application, but any device capable of serial communications can be used for remote mode operation. It is the responsibility of the programmer to control access to the communications network in the event that more than one device is connected. (Note: The DeviceNet protocol defines it's own mechanism to control access arbitration.)

While the end applications are extremely varied, almost all motion control applications share at least some common traits. The motion system needs to be initialized, configured, and the drive electronics enabled. These activities are normally accomplished at the beginning of the program and usually don't need to be repeated unless some exception has occurred and some possible exceptions will be discussed in a moment.

The initialization phase involves establishing communications with the various network nodes and defining an initial "Home" position for the controllers to operate from. This position usually differs from the actual "Home" position required by the application. Once the initial "Home" position has been established, the servo loop parameters should be loaded with values that provide the system response required by the application. The responsiveness of the control loop is highly application dependent and may even vary to some degree within an applications program. This usually occurs when there are wide variations in load such as a vertical lifting application. Discussion regarding the configuration of the servo parameters is contained in Appendix F. Once the filter has been configured, the drive can be enabled and the motor should begin to servo in the temporary "Home" position.

At this point it is usually applicable to initiate a "Homing Routine" to prepare the device for its intended task. In most cases where absolute system position isn't maintained once power is lost it is desirable to locate a "Home Sensor" at one end of each axis range of travel. This will allow the "Home Routine" to seek the sensor in a known direction. Initiate a move in velocity mode in the direction of the sensor while polling the node for its current status. A moderate velocity may be used to locate the sensor as more precise detection can be accomplished later. Testing the status responses will allow detection of a "Home Sensor" that has been connected to one of the External Event inputs provided on the external interface connector located on the rear of the unit. Utilization of these inputs allows this functionality to be implemented with little difficulty and minimizes the resources necessary to develop a complete applications solution. Inputs for hard overtravel limits as well as an emergency stop input are also available on the external interface connector. It is recommended that these inputs be used to detect serious error conditions that can develop from component failure or other fault conditions that require operator intervention to recover from. Once the "Home Sensor" is initially located, it is good practice to reverse the motor until the status input indicates that the axis has cleared the "Home Sensor". By again seeking the "Home Sensor" at a lower velocity, it will be possible to stop in precisely the same position each time the "Home Routine" is executed. Once the node is stopped in the "Home Position", and defined by the "Home" command, any offset can be invoked to position the device for it's intended application, and if necessary, another "Home" instruction can be issued to mitigate the need for maintaining a position offset in the host application program.

This process should be repeated for each axis in the system. Once the initialization is complete, the system is ready to operate in the intended application.

The system status responses provide a wealth of information about the condition of each node in the system. It is useful for controlling operational flow as well as detecting system level errors. When implementing a position move for example, it is normally good practice to insure that a commanded profile begins to execute before attempting to detect whether or not it has finished. In a distributed control system, there can be a variety of reasons for an instruction being ignored by a node. These can range from a data collision on the network to noise, which may have been induced from an outside source. But without verifying the beginning of a move, and detecting move complete and motor in position instead, the host program controlling the application may be tricked into believing that the motor is in a position it hasn't moved to.

By following good installation practices and taking a logical approach to program development, most of the pitfalls normally associated with integrating an application can be avoided. The time and effort spent planning and developing a sound installation can eliminate many hours of debugging later.

Backlash Compensation in Software:

Backlash is an integral part of most mechanical systems, especially where gearing is utilized to obtain additional mechanical advantage over the load. In situations where accuracy and repeatability are critical, backlash can be extremely problematic. Machinists have performed backlash compensation for years by always approaching the load from the same direction. This method is useful in eliminating the error induced by mechanical backlash but is not always practical in automated operations. An alternative often used in closed loop digital control systems involves adding or subtracting a known amount of backlash from the destination position, based on the direction of travel. In both cases, the amount of compensation required is determined prior to each operation since a variety of elements including load, temperature, and type of operation can affect the accuracy of the mechanical system. To overcome these variations, the backlash is normally measured during the initialization of the system and the result is used until the next initialization. In some instances, it is necessary to allow the mechanism to "warm up" prior to performing the final initialization sequence before operation.

Current Limiting and Torque Control:

Both the Linear and PWM versions of the MVP[®] Servo Controller provide programmable output current protection. The ANO command allows the user to program the maximum allowable continuous output drive current supplied to the motor. This feature provides not only short circuit protection for the internal drive circuitry, but also protects the motor from potentially harmful high currents that can occur during locked rotor conditions. The following table diagrams the programming parameters for the available output range for each device. **The power up default setting for both module types is zero current (2047 decimal).**

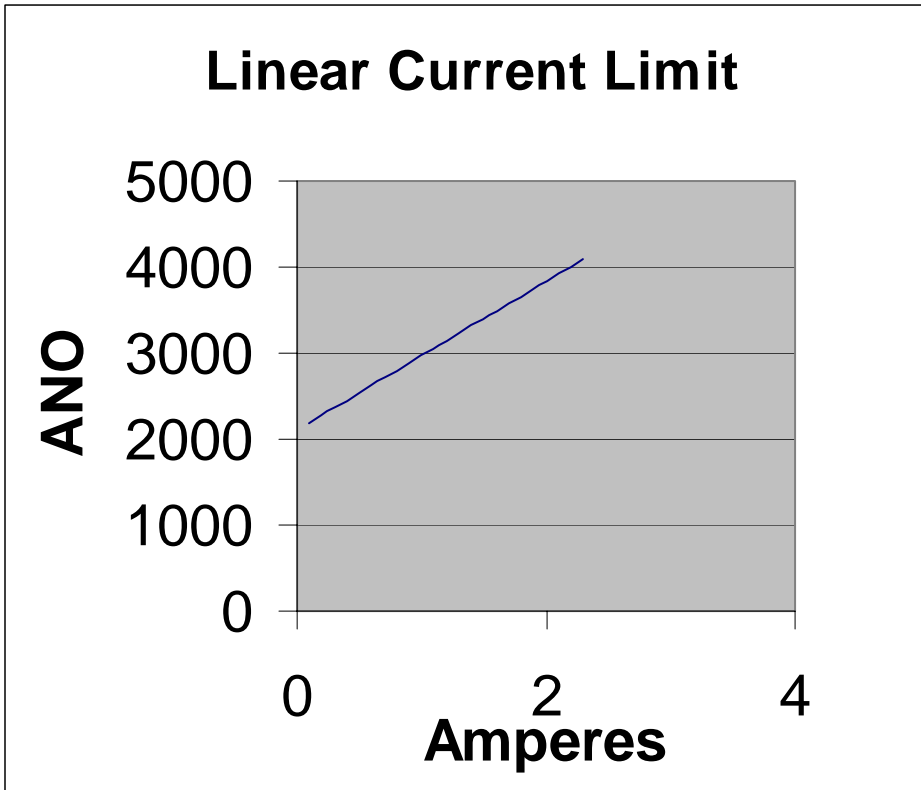

Amps	ANO
0.1	2190
0.2	2277
0.3	2364
0.4	2450
0.5	2537
0.6	2623
0.7	2710
0.8	2796
0.9	2883
1	2969
1.1	3056
1.2	3142
1.3	3229
1.4	3316
1.5	3402
1.6	3489
1.7	3575
1.8	3662
1.9	3748
2	3835
2.1	3922
2.2	4008
2.3	4095

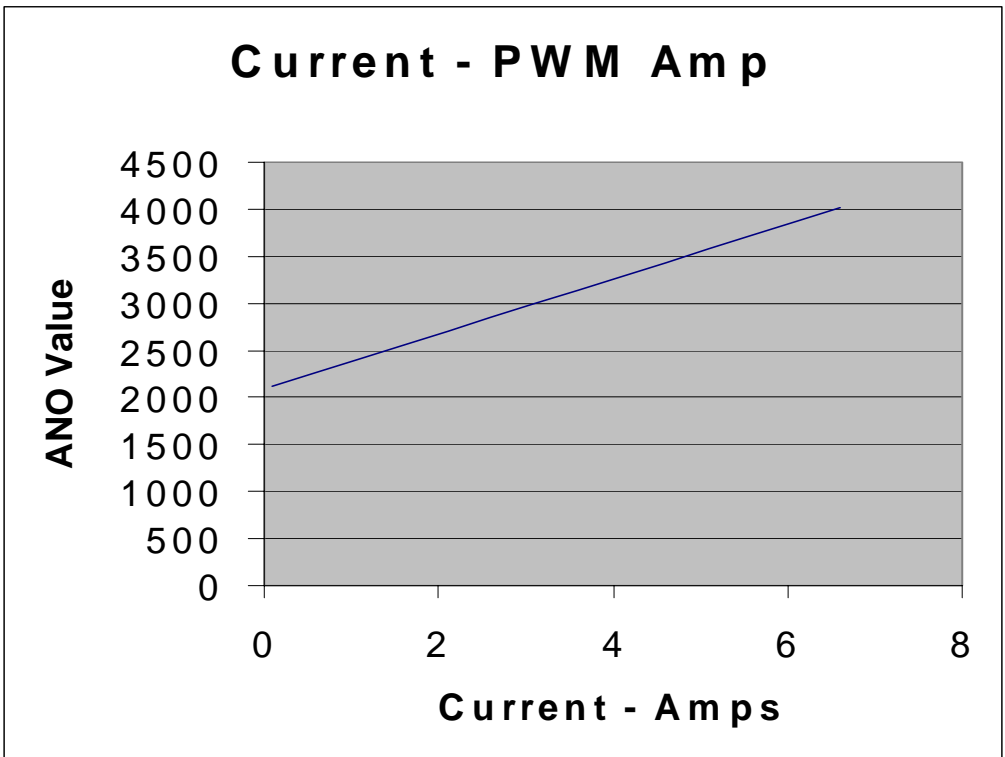

Amps	ANO
0.1	2128
0.6	2273
1.1	2418
1.6	2563
2.1	2708
2.6	2854
3.1	2999
3.6	3144
4.1	3289
4.6	3434
5.1	3580
5.6	3725
6.1	3870
6.6	4015

When the programmable output current capability is used in conjunction with the programmable following error limit feature, torque limiting or torque control mode operation can be implemented. In this instance, the servo loop should be configured for following error recovery. (**FA=2**) The default dynamic following error value (**FD**) is set to 1500 quadrature counts. This is .75 motor shaft revolutions in a system with a 500 line encoder. When the following error exceeds the programmed amount (1500 counts), the servo loop stops producing trajectory data until this error is recovered. This contains the accumulated following error within the programmed limit. Since the motor current is limited, so is the available torque. If the current is insufficient to allow the motor to produce enough torque to recover the following error, the MVP® will supply this “stall torque” indefinitely. If the motor is able to recover the following error, the trajectory generator will resume operation on the next filter sample and the motor will servo normally. The dynamic following error is programmable using the **FD** command and both of these parameters are programmable on the fly to allow flexibility in applications where varying load conditions are a factor. The torque developed by a motor per ampere of input current is known as the **torque constant (K_T)**. This definition is specific to brush type and electronically commutated motors. This constant is temperature dependent and can be mathematically derived from the **Back EMF constant (K_E)** which can be found on the motor data sheet.

$$K_T \text{ [oz-in/amp]} \approx 1.35 \times K_E \text{ [mV/rpm]}$$

If the programmable current limiting feature is not required by the application, the MVP® can be configured to allow the drive to supply maximum motor current on demand, freeing the Digital to Analog converter to set the current for general purpose use. Operation in this manner does not compromise the short circuit protection of the drive components.

Local Mode: Prior to entering local mode, **remove power to the unit** as some configuration options are determined at power up. Local operating mode provides closed loop speed control or position control using a potentiometer or other analog signal source as an input command. The configuration switches are designed to provide you with a wide range of operating options. Once configured, the MVP® 2001 will become fully functional immediately upon power-up. **It is important to verify all connections prior to power-up to avoid unintended consequences.** The analog input command **must** be maintained between **0-5VDC**. The resolution of the port is +/-512 steps or 9 bits. This allows bi-directional position and velocity control with 2.5 VDC being the “zero” input command. Although some internal hardware and software filtering is provided, you should make sure during installation that no extraneous noise is induced into the control loop. To set the controller for **Local Mode** move **Switch 1 to on** and **Switch 2 to off**: the balance of the switches will be set depending on the subsequent Modes

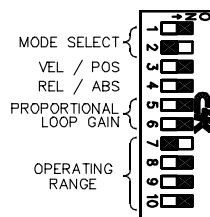

Note that the DIP switch labels on this diagram are functional labels and do not correspond to the labels printed on the front of the module.

Local Velocity Control (Switch 3 = OFF): Local Velocity Control has two functional modes: Absolute and Relative. Regardless of which of these modes is selected, the actual change in motor shaft velocity for an incremental change in the output command voltage is determined by the resolution of the encoder feedback device and the system sampling frequency. For the MVP® 2001 the control loop expects to receive 33.3 encoder quadrature feedback pulses per second for each velocity unit specified. The table below illustrates the incremental velocity delta for some of the more commonly available encoder resolutions. [33.3 quadrature pulses/sampling period * 60 = 2000 pulses/minutes.] The default sampling period in local mode is 500 μs.

Encoder Resolution	Quadrature	rpm/unit	Example
1000	4000	.50	2000/4000 = .50 rpm/step
500	2000	1.0	2000/2000 = 1.0 rpm/step
200	800	2.5	2000/800 = 2.5 rpm/step
100	400	5.0	2000/400 = 5.0 rpm/step
16	64	31.25	2000/64 = 31.2 rpm/step
15	60	33.33	2000/60 = 33.33 rpm/step
10	40	50.0	2000/40 = 50.0 rpm/step

For example the resolution of the input A/D converter is +/-512, 5 VDC/512 = .0097 Volts/bit, with 2.5 VDC being the “zero” input command. Therefore, with the lowest operational range selected (through manipulation of switches 7-10), the shaft velocity of a 500 cpr encoder with an input voltage command of 2.12 Volts produces an output command value of 77 velocity units. Multiplying this value by 1.0 from the table above for 500 line encoders provides a command velocity of 77 rpm. For increased functionality, switches 7 through 10 allow you to select from five range multipliers from 1 to 80 which can be applied to the initial base velocity. The multipliers for the available ranges are as follows:

Switch	7	8	9	10	Multiplier
	On	On	On	On	1
	Off	On	On	On	4
	On	Off	On	On	20
	On	On	Off	On	40
	On	On	On	Off	80

In **Absolute Velocity Control (Switch 4 = ON)**, the motor shaft velocity is the value read from the analog input or potentiometer multiplied by the range selected with switches 7 through 10. **Switching between ranges is allowed at any time.** The new range will become effective within 500µs. This mode allows you to select a coarse velocity value before fine tuning.

In **Relative Velocity Control (Switch 4 = OFF)**, the motor shaft velocity is calculated in the same manner as in Absolute Velocity Control above. The difference in this operating mode is that once a velocity close to the desired velocity is achieved, in absolute mode, switching to relative mode and selecting a lower range on the fly will allow you to “tune” the final velocity to precisely your desired value.

Local Mode Control Loop (Gain) Configuration: Switches 5 and 6 allow you to select four different proportional gain values. The gain selected is determined by the binary encoding of these switches. Switch 5 is the least significant bit. The lowest gain is enabled with **both** switches (5 and 6) = **On**. The highest gain is selected with **both** switches (5 and 6) = **Off**. **Switching from Velocity Control to Position Control is not possible without shutting down and repowering the MVP® module.** The operational mode as well as the gain configuration is determined at power-up.

DeviceNet™ Mode: In this mode, the DeviceNet™ protocol is followed. The MVP® is a Position Controller Object (device type 10 hex). Refer to page 10 for more information regarding DeviceNet™ Mode Operation. DeviceNet™ is automatically enabled and will respond to a DeviceNet™ message.

Appendix A

BASIC DEVELOPER'S KIT CONTENTS

- 1 RS-232C Serial Cable
- 1 Set PWM Duty Cycle Jumper (PWM Version Only)
- 1 Precision Potentiometer Assembly
- 2 Software Demo Diskettes
- 1 24 VDC Power Supply
- 1 Universal Power Cable
- 1 Encoder Cable
- 1 MVP® 2001 Operator's Manual

OPTIONS

- Macro Module (For stand alone applications)
- RS-485 Serial Converters
- DIN Rails (includes mounting screws & washers)
- Motors, Gearheads, Encoders, Custom Servos
- Connector Packs (PWM/Linear)(requires crimping tool to install on cable)
- 25 to 9 Pin Serial Adapters
- Custom Cabling
- Custom Software / Firmware
 - Electronic Gearing
 - Step-Direction Control
 - Labview TM Virtual Instruments
 - Example Source Code

PRICING (subject to change)

• MVP modules:	Quantity	With Linear Drive	With PWM Drive
	1-9	\$555.00	\$595.00
	10-24	\$540.00	\$580.00
	25-99	\$525.00	\$565.00

OEM Pricing = CALL

- Developers Kit Hook-up pak: Includes
- Power Supply, Cable Kit (including pot), 25-9 pin serial adaptor & jumpers for PWM and Demo Software. = \$88.00. Motor/Gearhead + MVP Module + Encoder are extra (ie. not included in the \$88.00 Hook-up pak)
- Call for Motor, Gearhead & Encoder price, as prices vary considerably
- RS-485 Converter = \$85 (all quantities)
- DIN Rail Mount = \$20 (all quantities)
- Connector Packs: PWM = \$15; Linear = \$10 (all quantities)

APPENDIX B

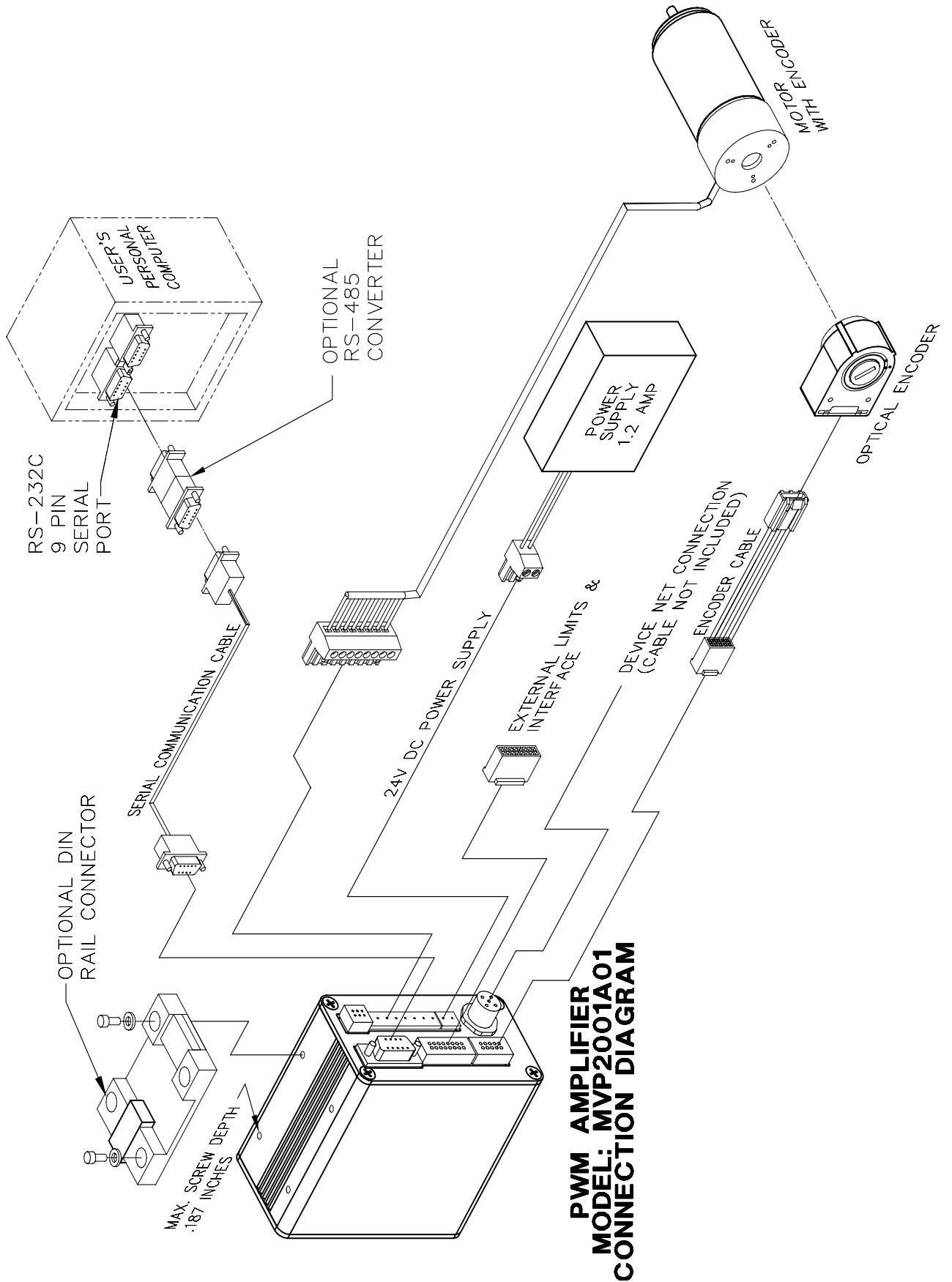

APPENDIX B

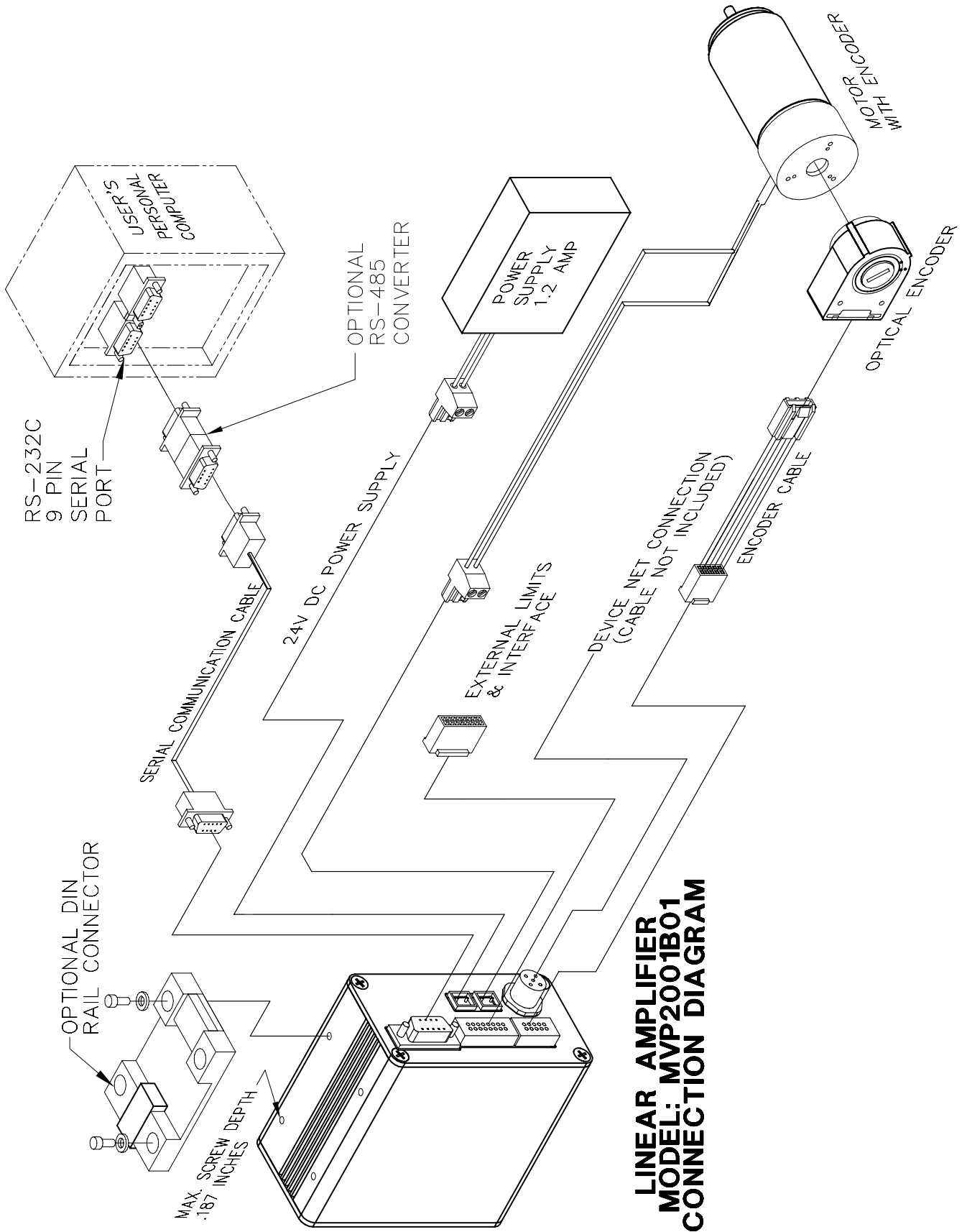

**LINEAR AMPLIFIER
MODEL: MVP2001B01
CONNECTION DIAGRAM**

Appendix C

Troubleshooting: Should you encounter difficulties with the operation of your MVP® controller, remove power from the unit and verify all connections as outlined in Appendix E of this manual and reapply power.

To make sure you are operating in the Local Mode, configure the front panel switches as follows:

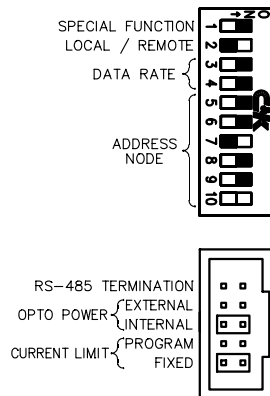

Apply power and observe the LED display and verify that every LED flashes as the unit performs the start up diagnostics. The **Module/Net Status** LED and the **Move in Progress** LED's should remain illuminated when the diagnostics are completed. The motor should be running at a low to moderate speed and should maintain that velocity as it is loaded. If these conditions do not exist, contact MicroMo Electronics at 1-800-807-9166 (USA & Canada) for MVP® Technical Support assistance. Connecting the controller to a data terminal or computer in remote mode will aid in diagnosis of your problem.

In the Remote Mode (Switch 2 ON), after power is applied, the **Module/Net Status** LED will be flashing and the **Motor In Position** LED will be illuminated. The start up message "**MVP2001 Ready**" should appear on your communications terminal. At this point you should be able to issue serial commands to control the module. By issuing a "**Home**" command followed by an "**Enable**" command the motor should begin to servo in position. This can be verified by attempting to turn the motor shaft. The motor should resist the efforts to move it from the **Home** position manually. If these conditions do not exist, verify you have established communications. Recheck all connections and configuration settings. If necessary, contact MicroMo Electronics for assistance at (800) 807-9166 and ask for "MVP® Technical Support". In this case, you should be able to access the computer and controller while talking to the support engineer.

Appendix D

MVP® FREQUENTLY ASK QUESTIONS (FAQ'S)

What does an MVP® do?

Any MVP® module can provide single axis motion, position, and velocity control as well as torque limiting of both brushless and brush type motors. Using the on-board integral amplifier, motors up to about 100 Watts can be controlled. Using external amplifiers motors into the integral horsepower range can be controlled regardless of who they are made by. Communication between the module and the host can be accomplished via serial RS-232, RS-485 Multidrop, or Devicenet™ protocols.

Who do I call to discuss a specific application?

Contact MicroMo Electronics, Inc. at (727) 572-0131 [toll free 1-800-807-9166 from the USA or Canada] and ask for “MVP® Technical Support.”

How reliable is an MVP®?

MicroMo Electronics, Inc., the manufacturer of MVP® is an ISO9001 certified company. Every MVP® unit built undergoes stringent burn-in testing to assure high quality and reliability. MicroMo's engineers have years of experience in the motion control business, insuring that the MVP® design incorporates state of the art, proven, reliable technology. If you require detailed information before specifying, including results of our thermal, vibration and mechanical shock, electrical, and accuracy tests, contact MicroMo's Marketing Department for a copy of the complete validation report.

What sort of accuracy can I expect with an MVP®?

A system's positional accuracy is determined by a number of factors in a servo system. The encoder resolution and the ratio of the reduction gearing, if any, as well as the mechanical design of the drive system, are the primary considerations. Servo loop bandwidth should also be addressed when incorporating a high resolution encoder in a high speed application. MicroMo Electronics, Inc. has done applications using MVP® Series controllers that provide 0.02µm accuracy using our low resolution magnetic encoders with our coreless motors. Testing in similar micropositioning applications with our new high resolution magnetic encoders yields results which are an order of magnitude more precise. The primary obstacle to precise positioning is usually mechanical backlash in the gearing system or torsional resonance at the interface of the moving parts in the system. MicroMo offers some gearhead series in zero backlash versions for sensitive applications.

My system requires that on startup it must be in a defined position. Can I do this with an MVP®?

Yes. The MVP® provides a “homing” feature that allows the MVP® to always return to a predetermined position when commanded to do so.

How fast will an MVP® respond to an external stimulus?

The MVP® provides two external event inputs, two hard limit inputs, and one emergency stop input. The MVP can respond to any of these inputs in approximately 500 microseconds.

How can I synchronize my MVP® to external events?

The MVP® provides two external event inputs. These inputs are monitored and their states are reported to you. When one of these inputs changes, you can then command the MVP® to perform any function.

What safety features does the MVP® have?

The MVP® provides several safety features. The MVP® offers software configurable range limits and three hardwired inputs for overtravel limits and emergency stop. The MVP® can also be configured with action codes to provide “servo-off”, “hard stop”, and “soft stop” functions when limits are exceeded or when following error occurs.

At what point is it cheaper for me to buy a multiaxis system instead of stringing a number of MVP®s together?

The cost per axis curves never really cross. The decision to move to a centralized multi-axis solution is usually driven by performance and architectural considerations. If the application requires tightly coordinated two axis motion, a high performance multi axis solution may be in order. But if the requirement is simply to operate 20 conveyer lines, an X-Y stage, to coordinate the processing of products with PLC-based I/O, or coordinate sequenced activities, then a distributed single axis implementation using 1 or more MVP®s should be very competitive.

Can you provide me with a packaged, pre-configured solution?

In most cases involving systems up to 1 hp, yes. We also offer a Developer’s Kit which contains a linear or PWM MVP® module, gearmotor with encoder and connecting cable, an RS-232 serial cable, a precision potentiometer assembly, demo software, a 24VDC power supply, a universal power cable, an operator’s manual, and (optional) a 25 to 9 pin serial adapter.

What operating mode choices do I have?

In the “Local” operating mode (with no remote host), the MVP® provides velocity or position control using potentiometer input. Both relative and absolute operation are supported. Additionally, encoder following with scaling is also available. In the “Remote” mode (using a remote host), the MVP® operates as a slave to the master device and depends on the host for instructions. This behavior is consistent with the design constructs for distributed control architectures. Local Mode applications range from simple pump operations, to tracking an analog input signal to position a target in an ion beam. Remote Mode allows networked operation of up to 64 MVP® modules in an RS-485 Multidrop or DeviceNet™ environment.

When using “Local Velocity” mode, how can I change the MVP®’s velocity Range?

In “Local Velocity” mode, the MVP®’s range is set using dip switches 7 through 10. Each switch has a particular range “scale” associated with it when it is turned OFF. The scaling is as follows:

Sw7	Sw8	Sw9	Sw10	
1000	5000	10000	20000	(RPM)

*ALL SWITCHES ON IS 250 RPM

examples

To set a range of 5000 rpm, only sw8 would be turned OFF.

To set a range of 20,000 rpm, only sw10 would be turned OFF.

What is the difference between absolute and relative positioning?

Absolute positioning implies that you want to move a load, motor shaft, etc. to a predetermined point from “home” or “base” position (usually from position 0). Relative position implies that you want to move a given distance from your present position which is a position other than “home”.

I'm confused. When should I use RS-232, RS-485 or DeviceNet™?

Which way you decide to communicate and control the MVP® is dictated by the type of application you need to do. Traditionally, RS-232 is used in applications involving only two devices (usually a PC and an MVP®) over relatively short distances (up to 32 ft). RS-485 is used when many devices (up to 256 devices) need to communicate over the same medium—usually a twisted pair cable—and the distance between devices is relatively long (up to 4,000 ft). DeviceNet™ is a network that provides connections between simple industrial devices (like sensors and actuators) and higher level devices (PLCs and controllers). All MVP®s are able to communicate with other DeviceNet™ modules but do so only when the MVP® is part of a DeviceNet™ network.

Can an MVP® control linear motors?

Yes. As with any closed loop system, however, an encoder or other type of feedback device is still required.

Does the MVP® accommodate resolver feedback?

Yes. No modifications are required to use the MVP® in a resolver-based system or with other types of feedback devices as long as the feedback device used provides quadrature feedback. This is not uncommon with most types of high performance feedback devices.

How do I know if the MVP® is operating?

One indication that an MVP® module is working properly is the diagnostic sequence performed when power is first applied to the unit. You will know the unit is performing this diagnostic sequence by observing the sequential turning ON and OFF of all LED indicators at power up.

I've hooked up the MVP® but the motor just runs away. What do I do?

Recheck all motor connections and make sure the encoder is powered and properly connected. Recheck mode configuration dip switches.

How do I know if the MVP® is communicating with my serial interface and the proper baud rate has been selected?

If remote mode or serial communication is being used, a serial message “MVP2001 READY” will be received after the diagnostic sequence is performed.

How do I know if I need custom software for my application?

The MVP® was designed to be flexible and to provide many useful features, but if you feel your application requirements can not be met with the present MVP® functions, please contact MicroMo Electronics at (727) 572-0131 [800-807-9166 from the USA or Canada], and ask for “MVP® Technical Support”. Our engineering staff will be happy to go over your application in detail, and provide effective solutions to your problems.

How do I perform a diagnostic sequence if the MVP® is not performing the commands I just sent it?

The MVP® provides systems information when the “ST” or status command is used. A status response looks something like this:

0004 010A

The first part of the message (0004) is the node address, in this case node address 4. The second half of the message (010A) is the system status response represented by a hex number. The 16 bit representation would be 0000000100001010 Binary. Page 21 of the operator’s manual describes the meaning of each bit. In this example, the “motor is in position,” “command was recognized,” but the “motor is not enabled” (since bit 8 is one).

How can I determine the present system settings?

You can enter any command without an argument to verify the present setting.

How do I set the Node address in remote mode?

In remote mode, switches 5 through 10 set the node address for serial communications and DeviceNet™ communications. The address becomes the total sum of all switches selected. Each switch has a particular “scale” associated with it when it is turned OFF. The scaling is as follows:

Sw5	Sw6	Sw7	Sw8	Sw9	Sw10
1	2	4	8	16	32

- examples:
- to set address 1, only Sw5 would be turned OFF.
 - to set address 4, only Sw7 would be turned OFF.
 - to set address 10, Sw8 and Sw6 would be turned OFF.
 - to set address 20, Sw9 and Sw7 would be turned OFF.

What is the difference between “V” and “SP” velocity commands?

The “V” command activates the velocity mode and sets the speed at which the motor will run. The “SP” command sets the velocity at which the motor will run when a “move” in position mode is performed.

What are the MVP’s serial communications settings?

The MVP uses standard serial communications settings.

These include the following:

- 9600 baud N,8,1
- 19200 baud N,8,1
- 38400 baud N,8,1
- 57600 baud N,8,1

How do I send commands to the MVP?

Typically, each MVP has a unique address or ID. Every command must begin with this address and all parameters are separated by spaces. All commands *must* be terminated with a carriage return. For example: to home unit #4 the following instruction is sent “4 HO” terminated by a carriage return [ENTER key or Ascii character 13].

How is the MVP's serial response structured?

The MVP responds with its address header (typically 4 digits –address and leading zeros) a space and data response which can be 4 or 8 digits long depending on the type of data requested. For example a status response from unit #4 will be:

“0004 000A”. A position response might be “0004 00002710”.

Please note that these packets are preceded by a Carriage Return and Line Feed and are terminated with a Carriage Return and Line Feed.

Can I convert an RS232 version of the MVP to RS485 or vice versa?

Yes, all MVPs can operate in either RS232 and RS485. Please contact MicroMo Electronics, Inc. at (727) 572-0131 [toll free 1-800-807-9166 from the USA or Canada] and ask for “MVP” technical Support for help in this matter.

I tell the MVP to execute a Macro and nothing happens. What's wrong?

The MVP must be programmed properly before it can execute a Macro.

This programming includes “downloading” a command file previously created using the MVPDEMO2000 program. Once this takes place the “ME” instruction can command the MVP to execute the downloaded macro.

Note: The MVP must be configured for RS485 operation for Macro execution to take place.

Appendix E

External Connections:

Connections Common to Both PWM & Linear Versions

J1 RS-232C/485 Remote Communications Interface:

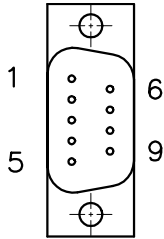

Pin 1	Not Connected
2	RxD/RS485-
3	TxD/RS485+
4	Not Connected
5	Ground
6	Not Connected
7	Not Connected
8	Not Connected
9	Not Connected

J2 External Interface Connector:

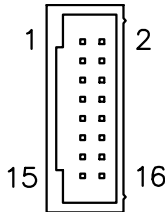

Pin 1	Analog Input Signal (0 to 5 VDC, 10 bits)
2	Analog Reference Ground
3	External Opto Power (+5 VDC)
4	Emergency Stop Input
5	Positive Hard Limit Input
6	Negative Hard Limit Input
7	External Event #2
8	External Event #1
9	External Drive Enable
	0 = disable
	1 = enable
10	DAC A Output (External Amplifier Command Signal)
11	DAC B Output (Programmable Analog Output)
12	PWM Sign
	0 = forward
	1 = reverse
13	PWM A Output (0-100% Duty Cycle PWM Command)
14	PWM B Output (50% Duty Cycle PWM Command)
15	+5 VDC
16	Ground

J3 Encoder Interface (HEDS 5000 Series Compatible):

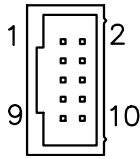

- Pin 1 Encoder Channel A Input
- 2 Encoder Power (+5 VDC)
- 3 Encoder Return (Ground)
- 4 Not Connected
- 5 Encoder Return (Ground)
- 6 Encoder Return (Ground)
- 7 Encoder Power (+5 VDC)
- 8 Encoder Channel B Input
- 9 Encoder Power (+5 VDC)
- 10 Encoder Channel Z (index) Input

J4 DeviceNet™ Interface:

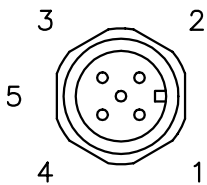

- Pin 1 Drain (Case)
- 2 V+ (Power Input)
- 3 V- (Power Return)
- 4 CAN_H (Communications Interface)
- 5 CAN_L (Communications Interface)

J5 Main Power:

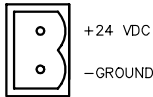

- Pin 1 +24 VDC
- 2 Ground

PWM Version Only:

J6 Motor Connection

Note: Brush type motors connect to Phase A and Phase B for PWM operation

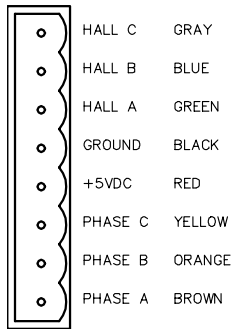

Linear Version Only:

J6 Motor Drive

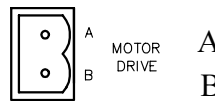

Pins

J7 PWM Mode

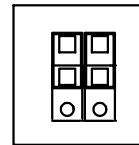

0–100% MODE

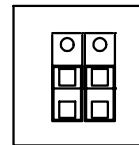

50–50% MODE

Appendix F

The following example routines are intended for use with the **MVP Demo** and **MACRO Downloader** software packages supplied with MVP2001 Series servo drives. They are designed to demonstrate the type of logical operational processes typically found in automation applications. For convenience, these examples may be found in file folders included within the **MVP Demo** software installation.

Initialization Examples:

This command file initializes and MVP servodrive, Node address = 4

```
4 sr 500      /*Use the "SR" command to set filter sample rate to 500us*/
4 ano 2000    /*The "ANO" command is used to set the programmable current limit*/
4 por 15000   /*Set the proportional gain to control motor stiffness*/
4 i 100       /*Use the integral gain to adjust position acquisition time*/
4 der 25000   /*The derivative gain affects the control loop damping*/
4 ho          /*The "HOMe" command defines the present position as position zero*/
4 en          /*The "ENable" command activates the drive amplifier to allow servoing*/
```

At this point the motor should be servoing in a stopped position. If this is not the case, encoder phasing may be the problem. This condition can be verified by invoking the "RE" (reverse encoder) command. Use the procedure in the file "revenc.cmd" to perform this test.

This command file initializes multiple MVP servodrive modules, Node address = 0

```
0 sr 500      /*Use the "SR" command to set filter sample rate to 500us*/
0 ano 2000    /*The "ANO" command is used to set the programmable current limit*/
0 por 15000   /*Set the proportional gain to control motor stiffness*/
0 i 100       /*Use the integral gain to adjust position acquisition time*/
0 der 25000   /*The derivative gain affects the control loop damping*/
0 ho          /*The "HOMe" command defines the present position as position zero*/
0 en          /*The "ENable" command activates the drive amplifier to allow servoing*/
```

At this point the motors should be servoing in a stopped position. If this is not the case, encoder phasing may be the problem. This condition can be verified by invoking the "RE" (reverse encoder) command. Use the procedure in the file "revenc.cmd" to perform this test.

Using Multiple Addresses:

Using address “0” via the RS-485 interface causes any MVP module receiving the message to respond to the command. This proves to be useful during initialization as well as for adjusting other global variables within a system. This address should not be used with commands where a response is expected. An alternative addressing scheme is detailed below. In this example, addresses (1) and (2) are used.

```
1,2 sr 500      /*Use the “SR” command to set filter sample rate to 500us*/
1,2 ano 2000   /*The “ANO” command is used to set the programmable current limit*/
1,2 por 15000  /*Set the proportional gain to control motor stiffness*/
1,2 i 100      /*Use the integral gain to adjust position acquisition time*/
1,2 der 25000  /*The derivative gain affects the control loop damping*/
1,2 ho         /*The “HOMe” command defines the present position as position zero*/
1,2 en         /*The “ENable” command activates the drive amplifier to allow servoing*/
```

Homing Examples:

In most position control applications, the system operates between defined mechanical limits. In order to establish a relationship between these limits and the servo controller’s position domain once the power-up initialization is complete, some type of “Homing” sequence usually performed. The motor is normally driven toward some type of sensor or hard stop having a known location. Once this position has been located, the servo controller’s location is redefined to permit the operation of the control program to function with the desired mechanical limits. The HP and LP commands are used to select the proper polarity of the HOME and LIMIT inputs as required.

This example illustrates a simple homing sequence using external event input #1 (J2-8).

```
4 ho           /*Designate initial HOME location*/
4 en           /*Enable drive amplifier*/
4 v 20         /*Activate velocity mode to seek “Home” sensor*/
4 st 4109      /*Check status for sensor active*/
4 ho           /*Execute “Home” function on detection of sensor*/
```

To use external event input #2 (J2-7), change the status mask to 16397.

This example illustrates a simple homing sequence using an end of travel hard stop.

Homing by this means usually doesn't provide the homing accuracy that can be achieved using switches, optical, magnetic, or inductive proximity sensors. In addition, utilizing this type of homing mechanism can potentially cause damage in geared mechanical systems.

```
4 v 20      /* Activate velocity mode to seek "Home" location*/
4 st 141    /* Check status for the following error flag*/
4 ho        /* Execute "Home" function on detection of the limit*/
4 la -100   /* Program a move to a location a safe distance from the limit*/
            /* to prevent the motor from overheating due to integration error*/
4 m         /* and move there.*/
```

This example illustrates a more complex homing sequence using external event input #1 (J2-8).

This routine demonstrates how to detect the activation of an over travel limit switch during the homing process. When the over travel limit is detected, the motor direction is reversed in order to continue the search in the opposite direction.

```
4 ho        /* Designate initial HOME location*/
4 en        /* Enable drive amplifier*/
4 ls 1      /* Set limit sequence behavior*/
4 ha 1      /* Arm the "HOME" input*/
4 v 20      /* Activate velocity mode to seek "Home" sensor*/
            /* Check for positive limit or "HOME" complete*/
4 st 8206 st 16394>done
4 v -20     /* Reverse the direction of travel*/
            /* Check for positive limit or "HOME" complete*/
4 st -32754 st 16394>done
done:
```

At this point the home sensor has been located and the home position has been determined. Additional homing can be implemented to enhance precision if necessary. It is also possible to use the over travel limit sensor to detect the home position.

This example illustrates a more complex homing sequence using external event input #1 (J2-8). In this case, the sensor is detected a second time to allow the axis to be homed on a particular edge of the sensors signal. For added precision, the motor velocity is reduced for the second approach.

```

4 ho      /*Designate initial HOME location*/
4 en      /*Enable drive amplifier*/
4 v 20    /*Activate velocity mode to seek "Home" sensor*/
4 ha 1    /*Arm the "HOME" input*/
4 st 4106 /*Check status for sensor active*/
4 v -2    /*Reverse the direction of travel*/
4 st 13   /* until the sensor is cleared.*/
4 v 1     /*Move toward sensor again*/
4 ha 1    /*Arm the "HOME" input*/
4 st 4106 /*and recheck status*/
4 ho      /*Execute "Home" function on detection of sensor*/

```

To use external event input #2 (J2-7), change the status mask to 16397. The secondary input can also be used to locate the motor on the encoder index channel if one is present after the initial homing routine using a sensor as described above is completed. Simply connect the index channel to the second input and use the same procedure as before, with the new status mask value.

Indexing Examples:

This example routine demonstrates mode 5 indexing embedded within normal positioning tasks. Additionally, the state of event input #2 determines the velocity and acceleration of the indexing operation by redirecting program flow. In this example, the index trigger source is via command from the host device.

```

4 itd 10          /*Set destination delay*/
4 is 10000       /*Set indexing velocity*/
4 ia 500         /*Set indexing acceleration*/
loop:           /*Flow control label*/
4 la 100000     /*Load first destination*/
4 sp 3000       /*Load initial move velocity*/
4 ac 300        /*Load initial move acceleration*/
4 m            /*Perform initial move*/
4 st 10 16394   /*Wait until complete, event input 0 or 1, ok */
4 id 500        /*Configure indexing destination*/
4 im 5         /*Select mode 5, relative/counts*/
4 itz 10        /*Set zero location delay time*/
4 io 124000     /*Select index final location*/
4 ic 20        /*Set number of indexing counts*/
4 ie 1         /*Enable indexing mode*/
4 itr         /*Provide serial indexing trigger*/
4 st 10 16394   /*Make sure indexing operation is complete*/
4 st 10 16394   /*Event input 0 or 1, ok */
4 st 10 16394

```

```

4 la 0                /*Load next conventional destination*/
4 sp 1000             /*Set desired velocity*/
4 ac 20               /*and acceleration*/
4 m                  /*Perform next conventional move*/
4 st 10>exit st 16394>slow /*Wait until complete, event input 0 or 1, ok */
slow:                /*Flow control label, slow motion operation*/
4 ia 20              /*Set indexing acceleration to slow*/
4 is 1000            /*Set indexing velocity to slow*/
4 itd 10             /*Increase index destination delay*/
4 st 10>loop st 16394>loop /*Execute next loop*/
exit:

```

This routine demonstrates indexing mode 0. This mode provides absolute indexing for a single index cycle. The trigger source can be either an external command or event input #1 (J2-8).

```

4 ho                /*Designate HOME location*/
4 en                /*Enable drive amplifier*/
4 por 12000         /*Tighten loop gain and*/
4 i 30              /*integral term*/
4 itz 10            /*Set zero delay in milliseconds*/
4 itd 10            /*Set destination delay in milliseconds*/
4 is 10000          /*Set indexing velocity*/
4 ia 100            /*Set index acceleration*/
4 id 500            /*Set index destination*/
4 io 0              /*Select final destination*/
4 im 0              /*Select index mode- 0 = absolute/single step operation*/
4 ie 1              /*Enable indexing mode*/

```

The system is now configured and is waiting for the index strobe on event input#1 Interface connector J2, pin 8. To trigger serially, use the ITR command.

This routine demonstrates indexing mode 1. This mode provides absolute indexing for an unlimited number of index cycles. The trigger source can be either an external command or event input #1 (J2-8). A second trigger will terminate execution

```
4 ho          /*Designate HOME location*/
4 en          /*Enable drive amplifier*/
4 por 12000   /*Tighten loop gain and*/
4 i 30        /*integral term*/
4 itz 10      /*Set zero delay in milliseconds*/
4 itd 10      /*Set destination delay in milliseconds*/
4 is 10000    /*Set indexing velocity*/
4 ia 100      /*Set index acceleration*/
4 id 500      /*Set index destination*/
4 io 0        /*Select final destination*/
4 im 1        /*Select index mode- 1 = absolute/repeat operation*/
4 ie 1        /*Enable indexing mode*/
```

The system is now configured and is waiting for the index strobe on event input#1. Interface connector J2, pin 8. To trigger serially, use the ITR command.

This routine demonstrates indexing mode 2. This mode provides absolute indexing for a predetermined number of index counts. The trigger source can be either an external command or event input #1 (J2-8).

```
4 ho          /*Designate HOME location*/
4 en          /*Enable drive amplifier*/
4 por 12000   /*Tighten loop gain and*/
4 i 30        /*integral term*/
4 itz 1       /*Set zero delay in milliseconds*/
4 itd 1       /*Set destination delay in milliseconds*/
4 is 10000    /*Set indexing velocity*/
4 ia 100      /*Set index acceleration*/
4 id 500      /*Set index destination*/
4 io 0        /*Select final destination*/
4 im 2        /*Select index mode- 2 = absolute/counts*/
4 ic 20       /*Select number of index counts*/
4 ie 1        /*Enable indexing mode*/
```

The system is now configured and is waiting for the index strobe on event input#1. Interface connector J2, pin 8. To trigger serially, use the ITR command.

This routine demonstrates indexing mode 3. This mode provides relative indexing for a single index cycle. The trigger source can be either an external command or event input #1 (J2-8).

```
4 ho          /*Designate HOME location*/
4 en          /*Enable drive amplifier*/
4 por 12000   /*Tighten loop gain and*/
4 i 30        /*integral term*/
4 itz 10      /*Set zero delay in milliseconds*/
4 itd 10      /*Set destination delay in milliseconds*/
4 is 10000    /*Set indexing velocity*/
4 ia 100      /*Set index acceleration*/
4 id 500      /*Set index destination*/
4 io 0        /*Select final destination*/
4 im 3        /*Select index mode- 3 = relative/single step operation*/
4 ie 1        /*Enable indexing mode*/
```

The system is now configured and is waiting for the index strobe on event input#1*/
Interface connector J2, pin 8. To trigger serially, use the ITR command */

This routine demonstrates indexing mode 4. This mode provides relative indexing for an unlimited number of index cycles. The trigger source can be either an external command or event input #1 (J2-8).

```
4 ho          /*Designate HOME location*/
4 en          /*Enable drive amplifier*/
4 por 12000   /*Tighten loop gain and*/
4 i 30        /*integral term*/
4 itz 10      /*Set zero delay in milliseconds*/
4 itd 10      /*Set destination delay in milliseconds*/
4 is 10000    /*Set indexing velocity*/
4 ia 100      /*Set index acceleration*/
4 id 500      /*Set index destination*/
4 io 0        /*Select final destination*/
4 im 4        /*Select index mode- 4 = relative/repeat operation*/
4 ie 1        /*Enable indexing mode*/
```

The system is now configured and is waiting for the index strobe on event input#1.
Interface connector J2, pin 8. To trigger serially, use the ITR command.

This routine demonstrates indexing mode 5. This mode provides relative indexing for a predetermined number of index counts. The trigger source can be either an external command or event input #1 (J2-8).

```
4 ho      /*Designate HOME location*/
4 en      /*Enable drive amplifier*/
4 por 12000 /*Tighten loop gain and*/
4 i 30    /*integral term*/
4 itz 1   /*Set zero delay in milliseconds*/
4 itd 1   /*Set destination delay in milliseconds*/
4 is 10000 /*Set indexing velocity*/
4 ia 100  /*Set index acceleration*/
4 id 500  /*Set index destination*/
4 io 0    /*Select final destination*/
4 im 5    /*Select index mode- 5 = relative/counts*/
4 ic 20   /*Select number of index counts*/
4 ie 1    /*Enable indexing mode*/
```

The system is now configured and is waiting for the index strobe on event input#1, Interface connector J2, pin 8.

This routine demonstrates indexing mode 5. This mode provides relative indexing for a predetermined number of index counts. The trigger source can be either an external command or event input #1 (J2-8).

```
4 ho      /*Designate HOME location*/
4 en      /*Enable drive amplifier*/
4 por 12000 /*Tighten loop gain and*/
4 i 30    /*integral term*/
4 itz 1   /*Set zero delay in milliseconds*/
4 itd 1   /*Set destination delay in milliseconds*/
4 is 10000 /*Set indexing velocity*/
4 ia 100  /*Set index acceleration*/
4 id 500  /*Set index destination*/
4 io 124000 /*Select final destination*/
4 im 5    /*Select index mode- 5 = relative/counts*/
4 ic 20   /*Select number of index counts*/
4 ie 1    /*Enable indexing mode*/
```

The system is now configured and is waiting for the index strobe on event input#1 Interface connector J2, pin 8.

Limit Handling Examples:

This example demonstrates a procedure for implementing over travel limits. These limits are useful for protecting the motor and drive system from damage that can occur when the system encounters an end of travel condition. Without protection, the servo controller will try to recover the following error that accumulates as the motor is stalled, producing high currents and high torque to be generated. The MVP2001 is equipped with 2 over travel limit inputs designed to provide real protection for drive system components. The positive limit input is located on the J2 connector, pin5, and the negative limit input is on J2, pin 6.

```
message Main Loop
start:
4 ho
4 en
4 por 12000
4 i 10
4 st 10 st 14
main:
message Executing primary routine
4 la 200000
4 sp 2000
4 ac 100
4 m
4 st 10 st 8202>pos_limit st -32758>neg_limit
message Returning to Origin
4 la 0
4 m
4 st 10>main st 8202>pos_limit st -32758>neg_limit
pos_limit:
message Moving to clear positive limit sensor
4 v -5
4 st 13 */Wait for limit input to become inactive/*
message Limit Clear....restarting routine
4 v 0
4 st 14>start st 10>start
gotostart

neg_limit:
message Moving to clear negative limit sensor
4 v 5
4 st 13 */Wait for limit input to become inactive/*
message Limit Clear....restarting routine
4 v 0
4 st 14>start st 10>start
gotostart
```

Program Flow Control Examples:

This routine demonstrates how to use event#, (J2-8) input to control program flow. This provides the ability to vary the operational sequence of an application or respond to exceptions such as limits or other error conditions.

```
loop:message Executing main loop
4 la 10000          /*Load primary move destination*/
4 sp 1000          /*Set initial velocity*/
4 ac 100           /*Set initial acceleration*/
4 m               /*Move to destination position*/
4 st 10 st 4106>loop2 /*Status test- Event input#1 active, goto loop2,*/
                  /*else continue*/
4 la 0            /*Load move back to origin location*/
4 m              /*Return move*/
4 st 10>loop st 4106>loop2 /*Status test-Event input#1 active, goto loop2,*/
                  /*else continue*/

loop2:message Executing secondary loop
4 la 100000       /*Load secondary destination*/
4 sp 7000        /*Set secondary velocity*/
4 ac 300         /*and acceleration*/
4 m             /*Initiate move to new destination*/
4 st 4106 10>loop /*Status test- Event input#1 active, continue*/
                  /*else return to primary operation*/
4 la 80000       /*Load next process position*/
4 m             /*Initiate move*/
4 st 4106 10>loop /*Status test- Event input#1 active, continue*/
                  /*else return to primary operation*/
4 la 40000       /*Load next process position*/
4 ac 200        /*and adjust acceleration, this step*/
4 m            /*Move to new location*/
4 st 4106 10>loop /*Status test- Event input#1 active, continue*/
                  /*else return to primary operation*/
4 sp 8000       /* Adjust velocity and acceleration for*/
4 ac 300        /*final secondary move*/
4 la 0          /*Load new destination position and move*/
4 m
4 st 10>loop st 4106>loop2 /*Continue with selected routine*/
```

Appendix G

Digital Filter Configuration:

Since the proper configuration of the digital filter parameters are crucial to achieving a stable system, it is necessary to have some understanding of the operation of PID control topologies. A block diagram of an analog PID control structure is illustrated below.

The PID transfer function (as a function of s) is:

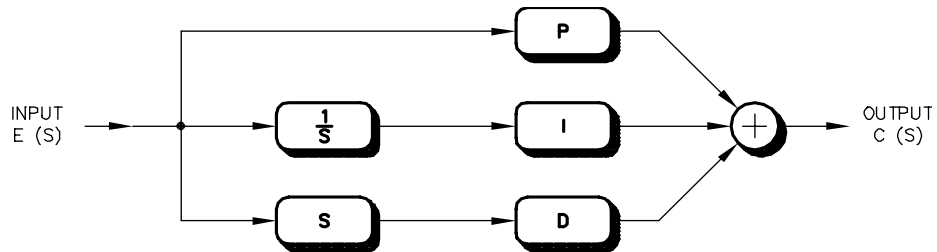

$$\frac{C(s)}{E(s)} = \frac{Ps + I + Ds^2}{s}$$

where: $C(s)$ is the output of the PID section

$E(s)$ is the input to the PID section (usually servo error)

P is the multiplier for the servo error

I is the multiplier for the integral of the servo error

D is the multiplier for the derivative of the servo error

s is the Laplace complex frequency variable

From the previous equation, it can be seen that the PID controller has a pole at $s=0$, and two zeros at:

$$s = \frac{-P \pm \sqrt{P^2 - 4DI}}{2D}$$

The two zeros are real-valued when $4DI \geq P^2$. A Bode plot of the PID transfer function with real valued zeros reveals that one of the zeros is used to brake the 20dB/decade descent associated with the integrator, and the other one is used to provide a 20dB/decade rise and positive phase lead required to stabilize the system.

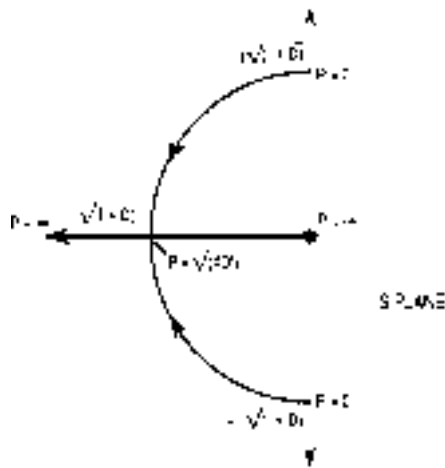

The **Proportional** term amplifies the error signal by a constant amount. However, the **P** term is not in series, but in parallel with **I** and **D**, which implies that **P** cannot be used to scale the transfer function amplitude at all frequencies. Instead, the **P** term interacts with the **I** and **D** terms to determine the placement of the zeros in the controller open-loop transfer function. A root locus solution to the numerator of the previous equation as **P** is varied with respect to **I** and **D** is illustrated here.

The **Integral** term gives the servo loop that inflexible, stubborn feel. Since the **I** term adjusts the amount of integrated error mixed to the output of the filter, and the value other than zero implies that **no** steady state error can be tolerated by the servo loop. Given sufficient time, the PID control loop will eventually servo the output to the exact value of the commanded input.

In the frequency domain, the **I** term also affects the placement of the zeros as demonstrated below. For $I = 0$, one of the zeros is at $s = -P/D$, and the other zero is at $s = 0$, which means that it will cancel the integrator pole at $s = 0$.

This makes sense intuitively since the integrator is turned off if I equals zero. As I increases, the servo loop becomes “snappier” and responds more quickly to steady state error.

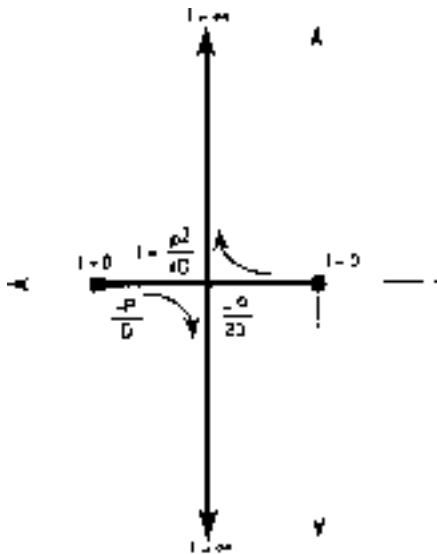

While adding an integrator does address the issue of steady state error, it can also have a negative impact on the system dynamics. The effect is most easily seen in the time domain. In a linear PID system that performs servo control, the controlled motor is initially at rest, with a zero position error. When torque is applied to the motor shaft changing it’s position, the control system senses a steady state error and tries to return the shaft to the commanded position. Since in this example the system is linear, the control voltage will continue to increase as a result of integrated error. While increasing the

control voltage could cause the motor to overheat if enough torque cannot be generated to overcome the error, this is not the only possible detrimental effect. If the applied torque is suddenly removed while the integrator output is large, the motor shaft will spin past the desired shaft position while the control voltage is “dumped”. Eventually a zero steady state condition is achieved, but in an underdamped (and potentially unacceptable) manner. Because this situation is similar to winding up a spring and then letting it go, the term wind-up is often used to describe it.

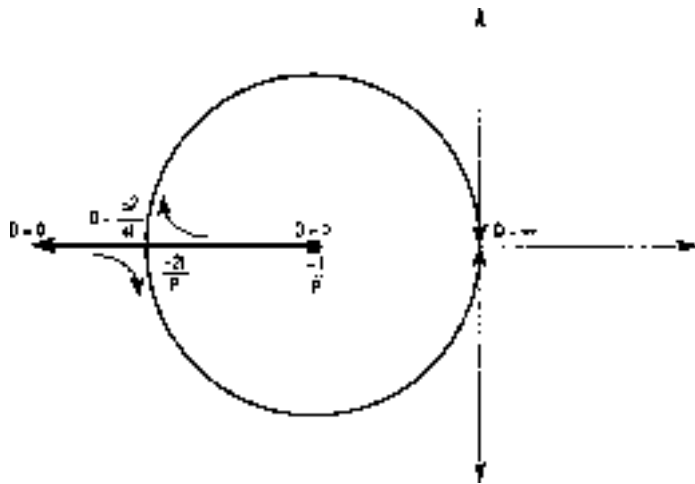

The **Derivative** term has the greatest effect on servo loop damping and stability. As demonstrated below, increasing the value of D from 0 to $P^2/4I$ causes both zeros to move toward $-2I/P$. As this happens, the higher frequency zero takes on a value that can provide useful phase lead to offset the phase lag introduced by poles elsewhere in the system. In a position servo, the feedback position signal is differentiated (either directly or indirectly) to create a signal proportional to the output velocity. In systems that use digital feedback mechanisms such as shaft encoders, velocity information is also quantized, typically in encoder counts per sample period. At low

velocities, the effects of quantization on system performance is pronounced because each quantization step represents a large portion of the velocity signal amplitude. The effects of this quantization error can be mitigated to some degree by extending the filter's amplifying period.

Digital PID controller transfer functions are calculated in much the same way as in analog systems, but because they are sampled systems, the Laplace transform of the s domain cannot be directly used as in analog calculations. To mitigate this problem, a separate frequency space called the z domain has been developed for sampled systems. Using the z domain, sampled approximations of many common functions can be represented using the variable "z" just as "s" is used to represent linear analog functions. Consider the following definitions.

$$\text{Integrator} = \frac{T}{z-1}$$

where:

z is the complex sampled frequency variable

T is the sampling frequency period, in seconds.

This form is derived from a step-invariant analysis..... the filter is constructed by dividing the Z transform of a specified input (a step function) into the Z transform of the desired output for that input (a ramp function).

The differentiator is simply the inverse, or:

$$\text{Differentiator} = \frac{z-1}{Tz}$$

Although these are not the only z-domain representations of these functions, they are widely used in control applications.

To mitigate encoder velocity quantization noise, the derivative function is followed by an “n-point averager”, which averages velocity information over a range of samples to provide finer resolution. However, this low pass filter also introduces phase lag proportional to n that counteracts the desired phase lead generated by the differentiator. To balance these two constraints, n is set equal to two, which effectively doubles encoder resolution per sample interval. The derivative stage transfer function is:

$$\text{VELOCITY} = \left(\frac{z-1}{Tz} \right) \left(\frac{1}{2} + \frac{1}{2z} \right)$$

The following diagram illustrates the PID controller as well as the transfer functions of parasitic effects found in the system.

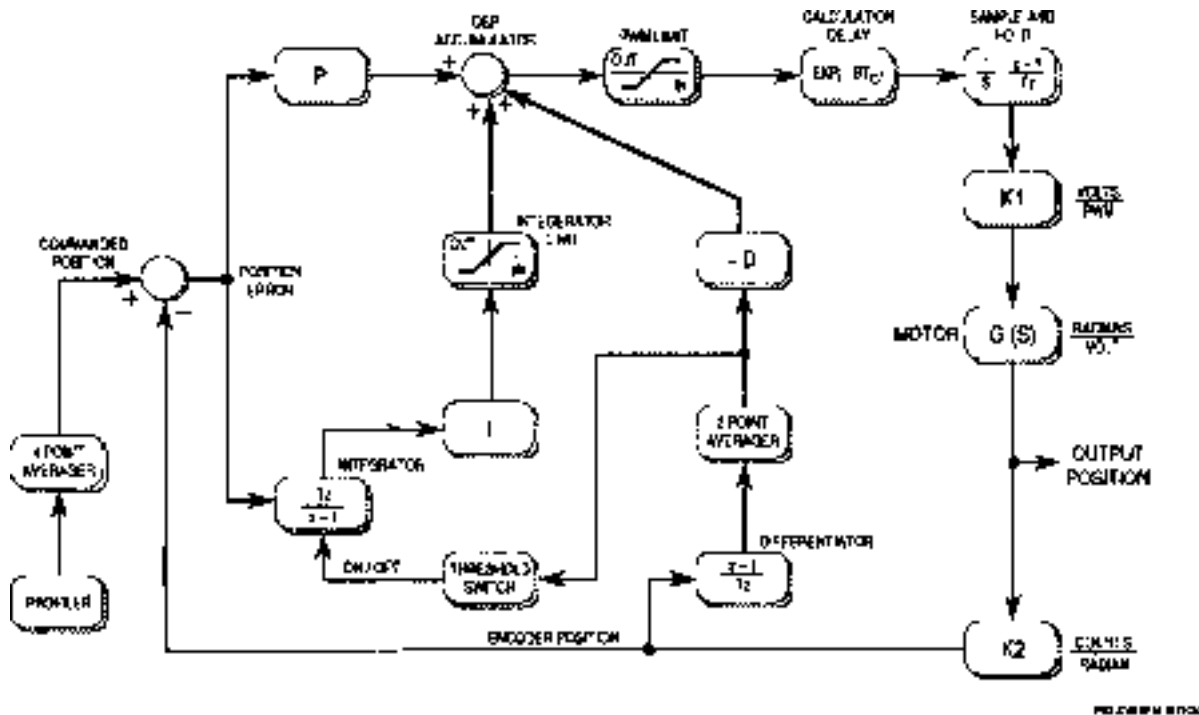

The default parameters for the digital filter have been calculated to provide stable operation in most applications. It should not be necessary to adjust the derivative term. In many cases, especially when using small, high speed motors. The proportional and integral terms are set to relatively low values and should be increased to provide the desired system response.

Appendix H

Linear or PWM Operation:

The MVP®2001 Controller is offered in two versions. Controllers equipped with linear drive amplifiers are intended for use with smaller coreless servo motors that contain precious metal commutation systems. The PWM (Pulse Width Modulation) version is intended for use with brush type servo motors with carbon brush assemblies and three phase brushless servo motors. PWM drive amplifiers tend to generate more electrical interference than their linear counterparts since the output stage is always driven to saturation. This switching characteristic, combined with the higher currents associated with motors of this type, contributes to the total amount of noise emitted by the system. The use of shielded wiring, separation of critical signals, and other noise reducing installation practices can significantly reduce the level, as well as the effects, of the radiated noise from the system.

In addition, the PWM drive amplifier can be configured to provide a PWM drive signal that expands from 0 to 100% to accommodate motors that have very low inductance. The alternative output configuration provides a signal that has a 50% duty cycle for zero velocity. In this mode, the duty cycle is reduced or increased as required by motion commands. This mode is intended for use with motors having higher inductance characteristics.

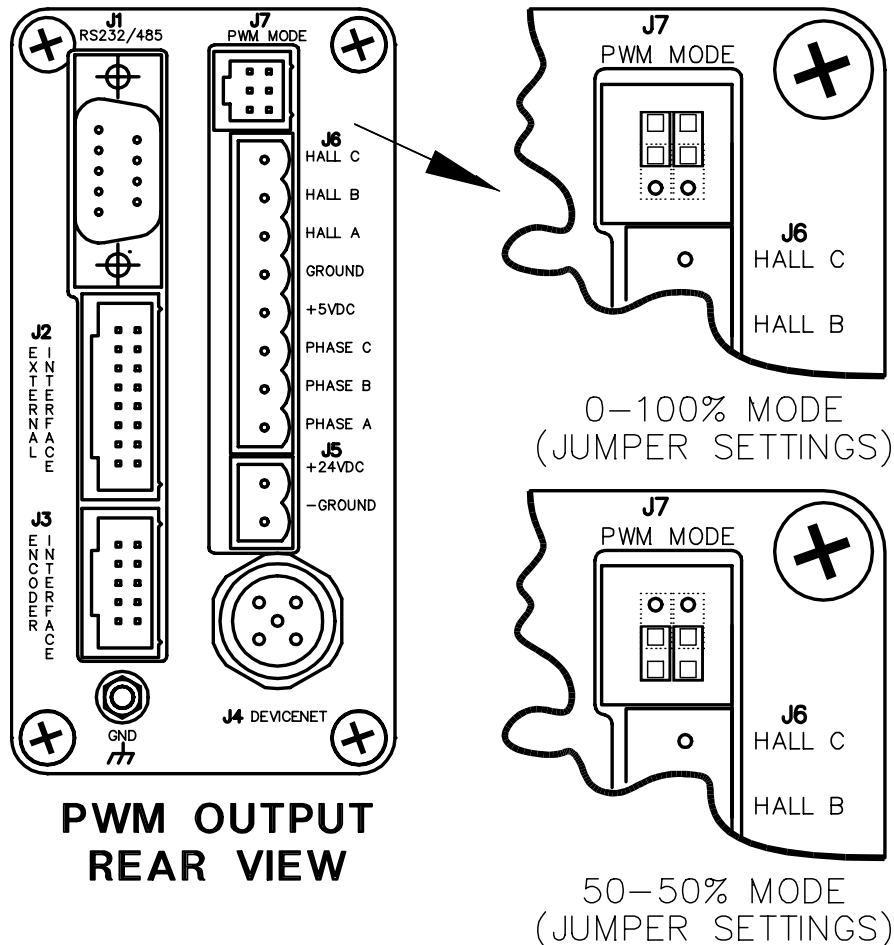

Appendix I

Mounting:

All MVP® modules can be mounted to machinery, in racks, or in cabinets with an optional DIN Rail mount or with mounting screws. Regardless of which mounting system you use, **do not penetrate screw holes deeper than 4.75mm (3/16 inch)** from the surface of the controller module, or irreparable damage to the circuit boards may result. The mounting scheme for DIN rails is shown in Figure 1. General mounting guidelines and mechanical references are shown in Figure 2.

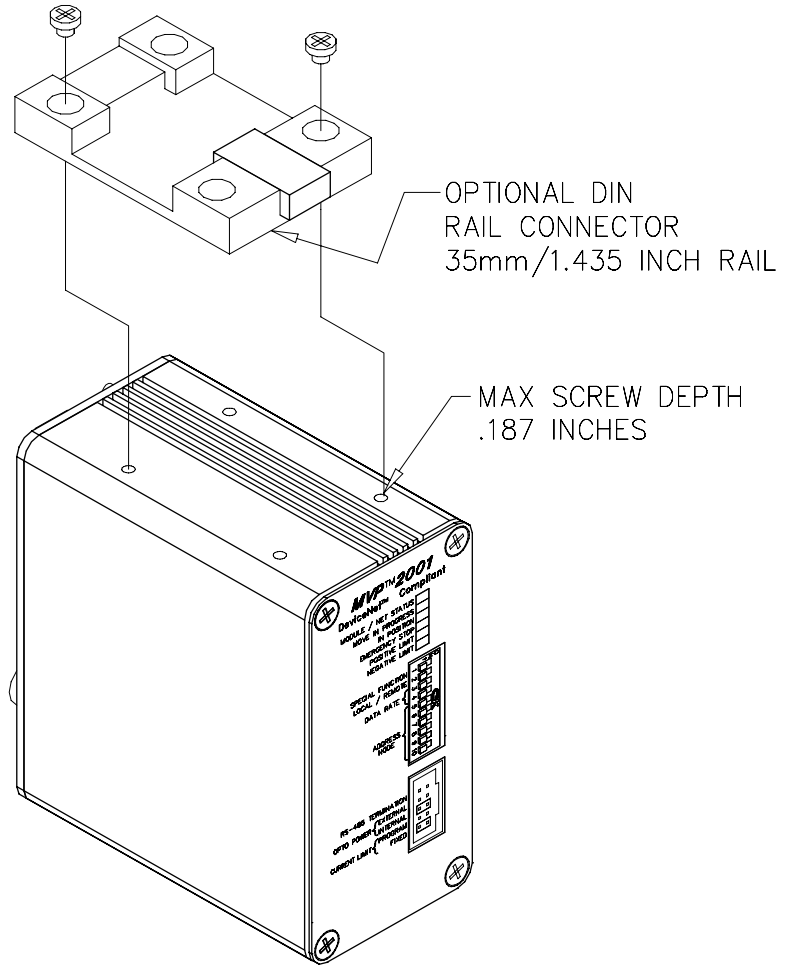

Figure

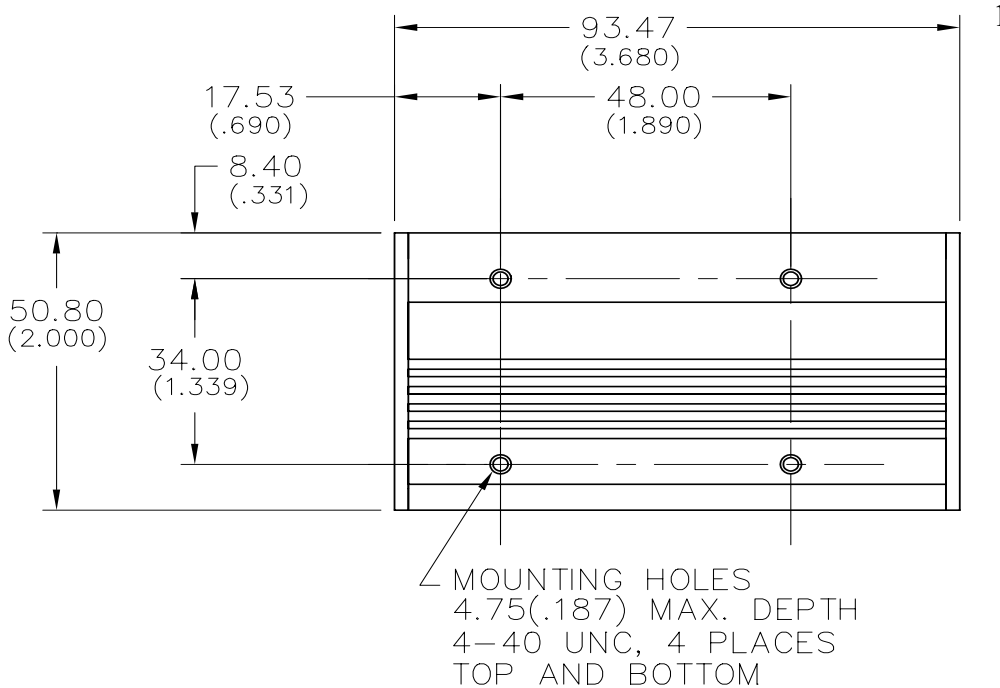

Figure 2

Appendix J

General Description:

The **MVP** (**M**otion **V**elocity **P**osition) Controller is a low cost, miniature, single axis “intelligent drive” that provides speed and position control of DC brush or brushless motors with an on-board integrated amplifier. Up to 64 motor axes can be controlled using an RS-485 Multidrop interface or the DeviceNet™ protocol.

- RS-232, RS-485 Multidrop, or DeviceNet™ (CAN) compatible interfaces
- Linear drive capable of 10 Watts continuous at 22°C ambient
- PWM driver capable of 50 Watts continuous at 22°C ambient
- Accepts Step/Direction Input / Encoder Tracking (optional)
- Torque Limiting Capability
- Programmable Current Limit / Short Circuit Protection
- Flash Based Parameter Storage / EDS
- Indexing & Registration Support (Single, Continuous, Count, Absolute & Rel)
- Position Capture (2)
- Macro Programing Support
- Custom firmware support for embedded OEM applications.

Performance (Remote Mode)

Position Range	± 2,147,483,647 quadrature counts
Velocity Range	up to 1,966,020 quadrature counts/sec
Velocity Accuracy	± 001%
Positional Accuracy	.18° (with a 500 CPR encoder & without gearhead)
Servo Loop Update Time	Programmable (200µs Min)
Servo Tuning	Programmable PID filter
Acceleration Range	32,767 quadrature counts/sample period (programmable)

Power Requirement

Single supply 24 VDC at 300mA, plus current to drive selected motor

Input Voltage Range Linear 18-40 VDC PWM 12-40 VDC

Communication

RS-232, RS-485 Multidrop, DeviceNet™ Demo software with source code support available for DeviceNet™, Visual BASIC, and LABView applications

Controller Inputs

Encoder	Two channel, Single-ended +5VDC TTL compatible, All Digital inputs isolated and interrupt driven
Analog	One analog input (0-5 VDC, 10 bit)
General Purpose	Two external event inputs, Two hard limits, One emergency stop
Opto Coupler Power	Input to supply external Power to Opto Couplers
Hall Sensors (3)	Only used for Brushless Motors (PWM version only)

Controller Outputs

PWM	0 - 100% One bit digital output (TTL) for external amplifier
PWM	50% - 50% One bit digital output (TTL) for external amplifier
Sign Bit	One bit digital output (TTL) for external amplifier (direction)
Analog	One 12 bit signed output for external amplifier (±10 VDC)
Analog	One 12 bit output (± 10VDC)(Also used for programmable current limit)

Drive Amplifier

MVP® 2001A PWM Amplifier Specifications @ 22°C (72°F)
MVP® 2001B Linear Amplifier 24.576 kHz switching frequency; 3 Amps continuous; 10 Amps peak
Outputs ±22 Volts DC at 1.0 Amp continuous; 3.5 Amps peak

Environmental

Controller Operating Temperature	0°C to 70°C (32°F to 158°F)
Ambient Operating Temperature (standard version)	0°C to 40°C (32°F to 104°F)
Ambient Storage Temperature (standard version)	-20°C to 85°C (-4°F to 185°F)
Humidity Tolerance (standard version)	80% Rh, non-condensing

MVP™ Motion Controller Dimensional Outlines

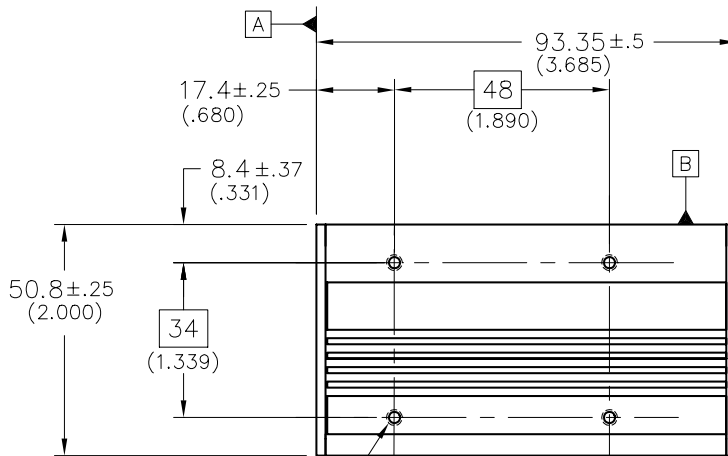

MOUNTING HOLES
 $\varnothing .75$ [A] [B]
 4.75(.187) MAX. DEPTH
 4-40 UNC, 4 PLACES
 TOP AND BOTTOM

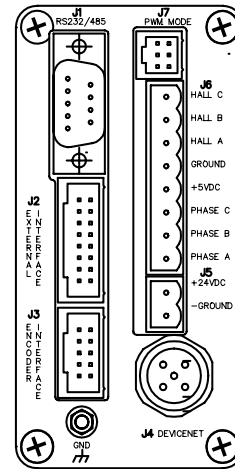

**PWM OUTPUT
REAR VIEW**

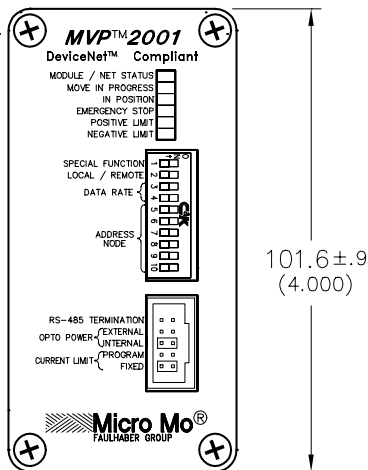

**ALL MODELS
FRONT VIEW**

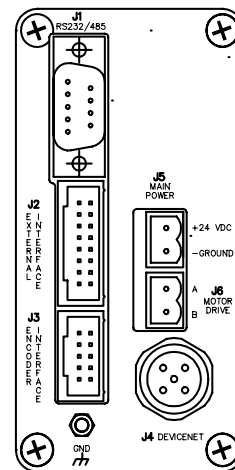
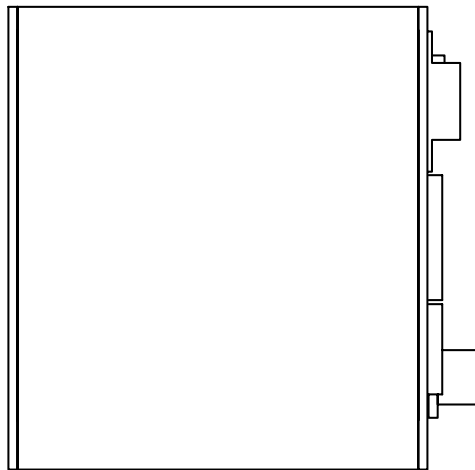

**LINEAR OUTPUT
REAR VIEW**

Ordering Information

MVP2001

Controller Series

A01

Driver and Communication:

- A01 = PWM, RS-232
- B01 = Linear, RS-232
- A02 = PWM, RS-485
- B02 = Linear, RS-485
- S... = Special Configuration (custom)

Options

MVP2001CONV = RS-485 Serial Converter for PC Serial Port.
 MVP2001DIN = DIN Rail Mounting Adaptor.
 For more options see Appendix A

MME02988K

Ver. 3.2

Appendix K

MVP® WARRANTY

All MVP® Series controller modules (excluding motors, gearheads, encoders, applications notes, software, cabling, and auxiliary devices) are warranted against defects in workmanship and materials for 1 year after date of shipment to the original purchaser. In the event of defects, MicroMo Electronics, Inc. will, at its sole option, repair or replace the defective controller covered by this warranty without charge. To avail themselves of this warranty, purchasers must obtain an RMA number from MicroMo's sales office, describe the alleged defect in writing, and return the properly packaged defective product within 30 days of discovering an alleged defect, with transportation and insurance prepaid. Replacement or repaired units will be reshipped at our expense to North American destinations only. This warranty shall also apply to controllers which have been repaired or replaced with respect to the original warranty commencement date. In no event will MicroMo be liable or held responsible under this warranty if the controller has been improperly stored, installed, used, or maintained, or if the purchaser has performed or permitted any unauthorized modifications, adjustments, or repairs to the product.

MicroMo Electronics, Inc. has no control over the use of this product or the associated applications notes and demonstration software. The applications notes and software are provided free of charge as is, for illustrative purposes, without warranty of any kind, either expressed or implied, including, but not limited to quality, performance, merchantability, or fitness for any particular use. Neither MicroMo Electronics, Inc., its affiliates, its employees, or its distributors shall be liable to the purchaser or any other person or entity with respect to any liability, loss, or damage caused or alleged to have been caused directly or indirectly by the product, the applications notes, engineering, application device, or associated software.

No person or entity, including any employee, agent, distributor, or representative of MicroMo Electronics, Inc. is authorized to make any representation or warranty on behalf of MicroMo Electronics, Inc. concerning any products, guidelines, or software except as set forth herein. No other warranties, either expressed or implied are made, and MicroMo Electronics, Inc. shall not be held liable or responsible for any incidental or consequential damages or claims, including, but not limited to breach of contract, negligence, strict liability, tort warranty, or patent or copyright infringement, and in no case shall MicroMo Electronics, Inc. be responsible or liable under this warranty or otherwise, even if MicroMo has been advised of the possibility of such damages as inability to use the product, increased operating costs from failure to be able to use the product, loss of anticipated profits, or other special, incidental, or consequential damages, whether similar or dissimilar, of any nature arising or resulting from the purchase, installation, removal, repair, operation, use, or breakdown of the product or any other cause whatsoever.