

Model 2231A-30-3 Triple-channel DC Power Supply

Reference Manual

077-1004-01 / September 2014



077-1004-01

A Greater Measure of Confidence



Model 2231A-30-3
Triple-Channel DC Power Supply
Reference Manual

© 2014, Keithley Instruments.

Cleveland, Ohio, U.S.A.

All rights reserved.

Any unauthorized reproduction, photocopy, or use of the information herein, in whole or in part, without the prior written approval of Keithley Instruments, is strictly prohibited.

All Keithley Instruments product names are trademarks or registered trademarks of Keithley Instruments. Other brand names are trademarks or registered trademarks of their respective holders.

Document number: 077100401 / September 2014

The following safety precautions should be observed before using this product and any associated instrumentation. Although some instruments and accessories would normally be used with nonhazardous voltages, there are situations where hazardous conditions may be present.

This product is intended for use by qualified personnel who recognize shock hazards and are familiar with the safety precautions required to avoid possible injury. Read and follow all installation, operation, and maintenance information carefully before using the product. Refer to the user documentation for complete product specifications.

If the product is used in a manner not specified, the protection provided by the product warranty may be impaired.

The types of product users are:

Responsible body is the individual or group responsible for the use and maintenance of equipment, for ensuring that the equipment is operated within its specifications and operating limits, and for ensuring that operators are adequately trained.

Operators use the product for its intended function. They must be trained in electrical safety procedures and proper use of the instrument. They must be protected from electric shock and contact with hazardous live circuits.

Maintenance personnel perform routine procedures on the product to keep it operating properly, for example, setting the line voltage or replacing consumable materials. Maintenance procedures are described in the user documentation. The procedures explicitly state if the operator may perform them. Otherwise, they should be performed only by service personnel.

Service personnel are trained to work on live circuits, perform safe installations, and repair products. Only properly trained service personnel may perform installation and service procedures.

Keithley Instruments products are designed for use with electrical signals that are measurement, control, and data I/O connections, with low transient overvoltages, and must not be directly connected to mains voltage or to voltage sources with high transient overvoltages. Measurement Category II (as referenced in IEC 60664) connections require protection for high transient overvoltages often associated with local AC mains connections. Certain Keithley measuring instruments may be connected to mains. These instruments will be marked as category II or higher.

Unless explicitly allowed in the specifications, operating manual, and instrument labels, do not connect any instrument to mains.

Exercise extreme caution when a shock hazard is present. Lethal voltage may be present on cable connector jacks or test fixtures. The American National Standards Institute (ANSI) states that a shock hazard exists when voltage levels greater than 30 V RMS, 42.4 V peak, or 60 VDC are present. A good safety practice is to expect that hazardous voltage is present in any unknown circuit before measuring.

Operators of this product must be protected from electric shock at all times. The responsible body must ensure that operators are prevented access and/or insulated from every connection point. In some cases, connections must be exposed to potential human contact. Product operators in these circumstances must be trained to protect themselves from the risk of electric shock. If the circuit is capable of operating at or above 1000 V, no conductive part of the circuit may be exposed.

Do not connect switching cards directly to unlimited power circuits. They are intended to be used with impedance-limited sources. NEVER connect switching cards directly to AC mains. When connecting sources to switching cards, install protective devices to limit fault current and voltage to the card.

Before operating an instrument, ensure that the line cord is connected to a properly-grounded power receptacle. Inspect the connecting cables, test leads, and jumpers for possible wear, cracks, or breaks before each use.

When installing equipment where access to the main power cord is restricted, such as rack mounting, a separate main input power disconnect device must be provided in close proximity to the equipment and within easy reach of the operator.

For maximum safety, do not touch the product, test cables, or any other instruments while power is applied to the circuit under test. ALWAYS remove power from the entire test system and discharge any capacitors before: connecting or disconnecting cables or jumpers, installing or removing switching cards, or making internal changes, such as installing or removing jumpers.

Do not touch any object that could provide a current path to the common side of the circuit under test or power line (earth) ground. Always make measurements with dry hands while standing on a dry, insulated surface capable of withstanding the voltage being measured.

For safety, instruments and accessories must be used in accordance with the operating instructions. If the instruments or accessories are used in a manner not specified in the operating instructions, the protection provided by the equipment may be

impaired.

Do not exceed the maximum signal levels of the instruments and accessories, as defined in the specifications and operating information, and as shown on the instrument or test fixture panels, or switching card.

When fuses are used in a product, replace with the same type and rating for continued protection against fire hazard.

Chassis connections must only be used as shield connections for measuring circuits, NOT as protective earth (safety ground) connections.

If you are using a test fixture, keep the lid closed while power is applied to the device under test. Safe operation requires the use of a lid interlock.

If a  screw is present, connect it to protective earth (safety ground) using the wire recommended in the user documentation.

The  symbol on an instrument means caution, risk of danger. The user must refer to the operating instructions located in the user documentation in all cases where the symbol is marked on the instrument.

The  symbol on an instrument means caution, risk of electric shock. Use standard safety precautions to avoid personal contact with these voltages.

The  symbol on an instrument shows that the surface may be hot. Avoid personal contact to prevent burns.

The  symbol indicates a connection terminal to the equipment frame.

If this  symbol is on a product, it indicates that mercury is present in the display lamp. Please note that the lamp must be properly disposed of according to federal, state, and local laws.

The **WARNING** heading in the user documentation explains dangers that might result in personal injury or death. Always read the associated information very carefully before performing the indicated procedure.

The **CAUTION** heading in the user documentation explains hazards that could damage the instrument. Such damage may invalidate the warranty.

Instrumentation and accessories shall not be connected to humans.

Before performing any maintenance, disconnect the line cord and all test cables.

To maintain protection from electric shock and fire, replacement components in mains circuits — including the power transformer, test leads, and input jacks — must be purchased from Keithley Instruments. Standard fuses with applicable national safety approvals may be used if the rating and type are the same. Other components that are not safety-related may be purchased from other suppliers as long as they are equivalent to the original component (note that selected parts should be purchased only through Keithley Instruments to maintain accuracy and functionality of the product). If you are unsure about the applicability of a replacement component, call a Keithley Instruments office for information.

To clean an instrument, use a damp cloth or mild, water-based cleaner. Clean the exterior of the instrument only. Do not apply cleaner directly to the instrument or allow liquids to enter or spill on the instrument. Products that consist of a circuit board with no case or chassis (e.g., a data acquisition board for installation into a computer) should never require cleaning if handled according to instructions. If the board becomes contaminated and operation is affected, the board should be returned to the factory for proper cleaning/servicing.

Safety precaution revision as of January 2013.

Table of Contents

Introduction	1-1
Welcome	1-1
Extended warranty	1-1
Contact information	1-1
CD-ROM contents	1-2
Key features	1-2
Standard accessories	1-2
Optional accessories	1-3
Available services	1-3
General ratings	1-3
Quick reference	2-1
Front-panel overview	2-1
Rear panel overview	2-2
Installing the system	2-2
Dimensions	2-2
Adjust the carrying handle	2-3
Power the instrument on or off	2-4
Self-test procedure	2-6
Check the output	2-7
Voltage output check	2-7
Current output check	2-8
What to do if the power supply does not turn on	2-8
General operation	3-1
Front-panel operation overview	3-1
Panel description	3-2
Indicator description	3-3
Basic settings	3-3
Set the voltage output or voltage limit for a specific channel	3-3
Set the current output or current limit for a specific channel	3-3
Save and recall the setups	3-3
Menu description	3-4
Default Set	3-4
Enable Channels	3-5
Protection Settings	3-5
Track CH1/CH2	3-6
Combine CH1+CH2	3-7
User Settings	3-9
System Info	3-10
Overtemperature protection (OTP)	3-11

Remote communication.....	4-1
Communication interface	4-1
2231A-001 communication connector	4-1
SCPI command reference.....	5-1
Common commands	5-2
*CLS.....	5-2
*ESE	5-2
*ESR?	5-3
*IDN?	5-3
*OPC.....	5-3
*RST	5-3
*SRE	5-4
*STB?	5-4
*TRG	5-4
*SAV	5-5
*RCL	5-5
*TST?	5-5
*WAI.....	5-5
*PSC	5-6
APPLY subsystem	5-6
[SOURce:]APPLY	5-6
[SOURce:]APPLY:VOLTage[:LEVel][:IMMediate][:AMPLitude]	5-6
[SOURce:]APPLY:CURRent[:LEVel][:IMMediate][:AMPLitude]	5-7
CALibration subsystem	5-7
CALibration:SECure:[STATe].....	5-7
CALibrate:VOLTage:LEVel	5-7
CALibrate:VOLTage[:DATA] <numeric value>.....	5-8
CALibrate:CURRent:LEVel	5-8
CALibrate:CURRent[:DATA] {<numeric value>}	5-8
CALibration:SAVe	5-9
CALibration:INITial	5-9
CALibrate:STRing	5-9
DISPlay subsystem	5-9
DISPlay[:WINDow][:STATe].....	5-9
DISPlay[:WINDow]:TEXT[:DATA]	5-10
DISPlay[:WINDow]:TEXT:CLEAr.....	5-10
INSTrument subsystem.....	5-10
INSTrument[:SELEct]	5-10
INSTrument:NSELEct.....	5-11
INSTrument:COMbine:SERies.....	5-11
INSTrument:COMbine:PARAllel.....	5-11
INSTrument:COMbine:TRACk	5-12
INSTrument:COMbine:OFF.....	5-12
INSTrument:COUPle[:TRIGger]	5-12
MEASure subsystem.....	5-12
MEASure[:SCALar]:VOLTage[:DC]?	5-13
FETCh[:VOLTage][:DC]?	5-13
MEASure[:SCALar]:CURRent[:DC]?	5-13
FETCh:CURRent[:DC]?	5-13
MEASure[:SCALar]:POWer[:DC]?	5-13
FETCh:POWer[:DC]?	5-13

OUTPut subsystem	5-14
OUTPut[:STATe][:ALL]	5-14
CHANnel:OUTPut[:STATe]	5-14
OUTPut:ENABle	5-14
OUTPut:TIMer[:STATe]	5-15
OUTPut:TIMer:DELay	5-15
OUTPut:TRACk[:STATe]	5-15
OUTPut:SERies[:STATe]	5-16
OUTPut: PARallel [:STATe]	5-16
SYSTem subsystem	5-17
SYSTem:ERRor?	5-17
SYSTem:VERsion?	5-17
SYSTem:REMote	5-17
SYSTem:LOCal	5-17
SYSTem:RWLock	5-18
SYSTem:MODUle?	5-18
SYSTem:BEEPer	5-18
STATus subsystem	5-19
STATus:QUEStionable[:EVENT]?	5-19
STATus:QUEStionable:ENABle	5-19
STATus:QUEStionable:CONDition?	5-19
STATus:PRESet	5-20
STATus:QUEStionable:INSTrument[:EVENT]?	5-20
STATus:QUEStionable:INSTrument:ENABle	5-20
STATus:QUEStionable:INSTrument:ISUMmary<x>[:EVENT]?	5-20
STATus:QUEStionable:INSTrument:ISUMmary<x>:ENABle	5-21
STATus:QUEStionable:INSTrument:ISUMmary<x>:CONDition?	5-21
STATus:OPERation[:EVENT]?	5-21
STATus:OPERation:CONDition?	5-22
STATus:OPERation:ENABle	5-22
STATus:OPERation:INSTrument[:EVENT]?	5-22
STATus:OPERation:INSTrument:ENABle	5-23
STATus:OPERation:INSTrument:ISUMmary<x>[:EVENT]?	5-23
STATus:OPERation:INSTrument:ISUMmary<x>:ENABle	5-23
STATus:OPERation:INSTrument:ISUMmary<x>:CONDition?	5-23
SOURce subsystem	5-24
[SOURce:]CHANnel:OUTPut[:STATe]	5-24
[SOURce:]CURRent[:LEVel][:IMMEDIATE][:AMPLitude]	5-24
[SOURce:]CURRent[:LEVel]:UP[:IMMEDIATE][:AMPLitude]	5-24
[SOURce:]CURRent[:LEVel]:DOWN[:IMMEDIATE][:AMPLitude]	5-25
[SOURce:]CURRent[:LEVel][:IMMEDIATE]:STEP[:INCRement]	5-25
[SOURce:]CURRent[:LEVel]:TRIGgered[:IMMEDIATE][:INCRement]	5-25
[SOURce:]VOLTage[:LEVel][:IMMEDIATE][:AMPLitude]	5-26
[SOURce:]VOLTage[:LEVel]:UP[:IMMEDIATE][:AMPLitude]	5-26
[SOURce:]VOLTage[:LEVel]:DOWN[:IMMEDIATE][:AMPLitude]	5-26
[SOURce:]VOLTage[:LEVel][:IMMEDIATE]:STEP[:INCRement]	5-27
[SOURce:]VOLTage[:LEVel]:TRIGgered[:IMMEDIATE][:INCRement]	5-27
[SOURce:]VOLTage:LIMIT[:LEVel]	5-27
[SOURce:]VOLTage:LIMit:STATe	5-28
Status model	5-29
Error messages	5-31
Additional Information	6-1
Additional Model 2231A-30-3 information	6-1

Maintenance	A-1
Introduction	A-1
Line fuse replacement.....	A-1
Cleaning the front-panel display	A-2

Introduction

In this section:

Welcome	1-1
Extended warranty.....	1-1
Contact information	1-1
CD-ROM contents	1-2
Button features	1-2
Standard accessories	1-2
Optional accessories	1-3
Available services.....	1-3
General ratings.....	1-3

Welcome

Thank you for using a Keithley Instruments product. The Model 2231A-30-3 Trip-Channel Programmable DC Power Supply is a flexible DC source designed to power a wide range of applications. It offers three independent and isolated power channels, allowing you to power circuits with different references or polarities. Each channel can be enabled or disabled as your application requires. Basic current accuracy is 0.2% for all channels and linear regulation delivers low noise – less than 5 mV_{pp}. Flexible display modes make it easy to use the two 30 V outputs in combination, and the DB9 interface connector makes it easy to build PC-based systems. This compact power supply covers a wide range of applications without covering a lot of bench space.

Extended warranty

Additional years of warranty coverage are available on many products. These valuable contracts protect you from unbudgeted service expenses and provide additional years of protection at a fraction of the price of a repair. Extended warranties are available on new and existing products. Contact your local Keithley Instruments office, sales partner, or distributor for details.

Contact information

If you have any questions after you review the information in this documentation, please contact your local Keithley Instruments office, sales partner, or distributor, or call Keithley Instruments corporate headquarters (toll-free inside the U.S. and Canada only) at 1-888-KEITHLEY (1-888-534-8453), or from outside the U.S. at +1-440-248-0400. For worldwide contact numbers, visit the [Keithley Instruments website](http://www.keithley.com) (<http://www.keithley.com>).

CD-ROM contents

The Model 2231A-30-3 Product Information CD-ROM is shipped with each power supply.

The Product Information CD-ROM contains:

- **Reference Manual:** Includes basic operation topics and maintenance information.
- **Performance Verification:** Contains performance verification procedures. Additional test equipment is required to complete the verification procedures.
- **Accessories information:** Documentation for accessories that are available for the Model 2231A-30-3.

For the latest drivers and additional support information, see the [Keithley Instruments website \(http://www.keithley.com\)](http://www.keithley.com).

Key features

The Model 2231A-30-3 has the following features:

- Three isolated output channels, including two 30 V at 3 A channels and one 5 V at 3 A channel
- 0.06% basic voltage accuracy
- 0.2% basic current accuracy
- Less than 5 mVpp ripple and noise
- Intelligent fan control, energy conservation and noise reduction
- Overvoltage and overtemperature protection

Standard accessories

Accessory	Part number
Documentation CD	077102700
Calibration report	001165500

You will also get one of the following power cords:

Option	Description
Option A0	North America and South America. The factory sets the line-voltage selector switch to 110 V.
Option A1	Universal Euro. The factory sets the line-voltage selector switch to 220 V.
Option A2	United Kingdom. The factory sets the line-voltage selector switch to 220 V.
Option A3	Australia. The factory sets the line-voltage selector switch to 220 V.
Option A4	Chile, Italy. The factory sets the line-voltage selector switch to 220 V.
Option A5	Switzerland. The factory sets the line-voltage selector switch to 220 V.
Option A7	Israel. The factory sets the line-voltage selector switch to 220 V.
Option A8	Argentina. The factory sets the line-voltage selector switch to 220 V.
Option A9	China. The factory sets the line-voltage selector switch to 220 V.
Option A10	India. The factory sets the line-voltage selector switch to 220 V.
Option A11	India. The factory sets the line-voltage selector switch to 220 V.
Option A13	Macao, Pakistan, Africa. The factory sets the line-voltage selector switch to 220 V.

Optional accessories

Optional accessory	Model number
USB communication adapter	2231A-001

Available services

For the current list of available services and accessories, upgrades, and options for your instrument, visit the Keithley Instruments website (<http://www.keithley.com>).

Service	Model Number
3-year factory warranty extended to 5 years from date of shipment	2231A-30-3-5Y-EW
3-year factory warranty extended to 1 additional year from date of shipment	2230A-30-3-EW

General ratings

The Model 2231A-30-3 instrument's general ratings and connections are listed in the following table.

NOTE

When the mains power supplied to the Model 2231A-30-3 exceeds 253 V, the maximum operating time at maximum output power is 1 hour. At the supply voltage range of 110 V, when the mains power exceeds 132 V, the maximum operating time at maximum output power is 1 hour.

Category	Specification
Supply voltage range	<ul style="list-style-type: none"> 110: 110 V-120 V 220: 220 V-230 V Each range capable of +/-10% tolerance, 47 to 63 Hz. Selectable by the line-voltage selector switch in the rear panel.
Environmental conditions	For indoor use only Operating: 0 °C to 40 °C (32 °F to 104 °F), 5% to 80% relative humidity at up to 40 °C (104 °F) Storage: -20 °C to 70 °C (-4 °F to 158 °F) 5% to 80% relative humidity at up to +40°C (104 °F) and 5% to 60% relative humidity above +40°C (104°F) up to +70°C (158°F) Pollution degree: 2

Quick reference

In this section:

Front-panel overview 2-1
 Rear panel overview 2-2
 Installing the system 2-2
 Self-test procedure 2-6
 Check the output 2-7
 What to do if the power supply does not turn on..... 2-8

Front-panel overview

The front panel of Model 2231A-30-3 is shown below. Descriptions of the controls on the front panel follow the figure.

Figure 1: Model 2231A-30-3 front panel

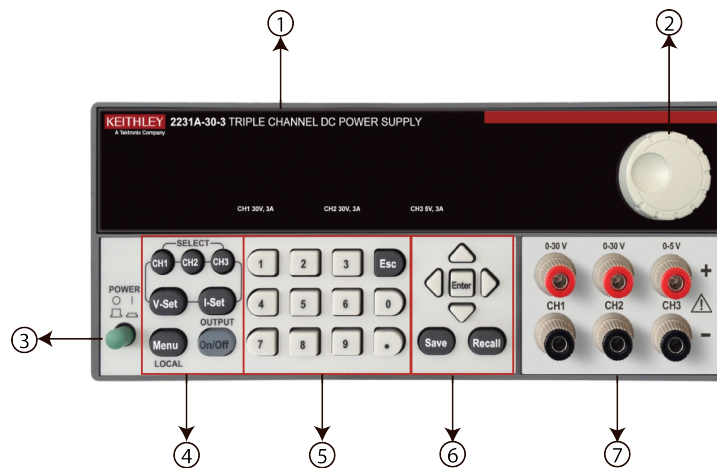

Item	Description
1	Vacuum fluorescent display (VFD)
2	Rotary knob
3	POWER button
4	Function buttons: Channel select buttons, V-Set (voltage setting), I-Set (current setting), Menu and Output On/OFF
5	Numeric buttons and ESC button
6	Up/Down/Left/Right arrow buttons, Enter button and Save/Recall function buttons
7	Output terminals

Rear panel overview

The rear panel of the Model 2231A-30-3 is shown below; descriptions follow the figure.

Figure 2: Model 2231A-30-3 rear panel

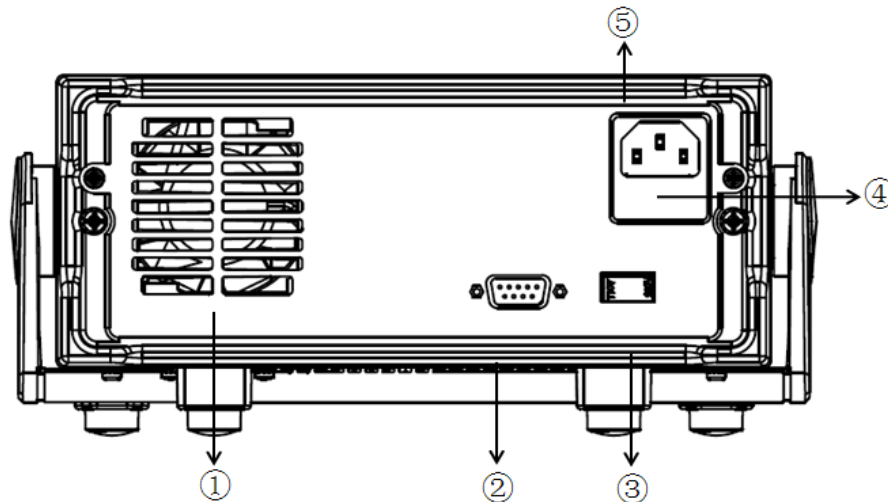

Item	Description
1	Ventilation holes
2	TTL interface connector for remote control
3	110 V/220 V AC power selection switch
4	Fuse compartment
5	AC power inlet

Installing the system

This section contains information on how to install your Model 2231A-30-3 power supply.

- Unpack the instrument and check that you received all the items listed as standard accessories.
- Check that you also received any other accessories that you ordered with your instrument.

Dimensions

The dimensions of the Model 2231A-30-3 power supply: 214.5 mm wide × 88.2 mm high × 354.6 mm deep.

Figure 3: Model 2231A front and rear panel dimensions

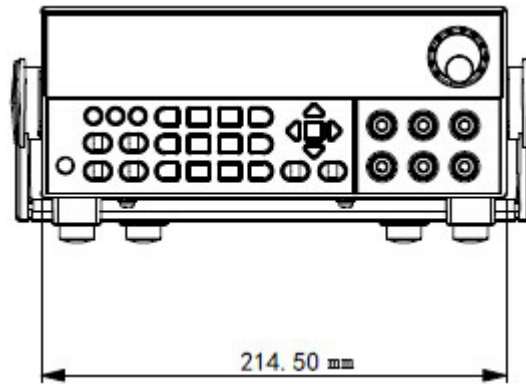
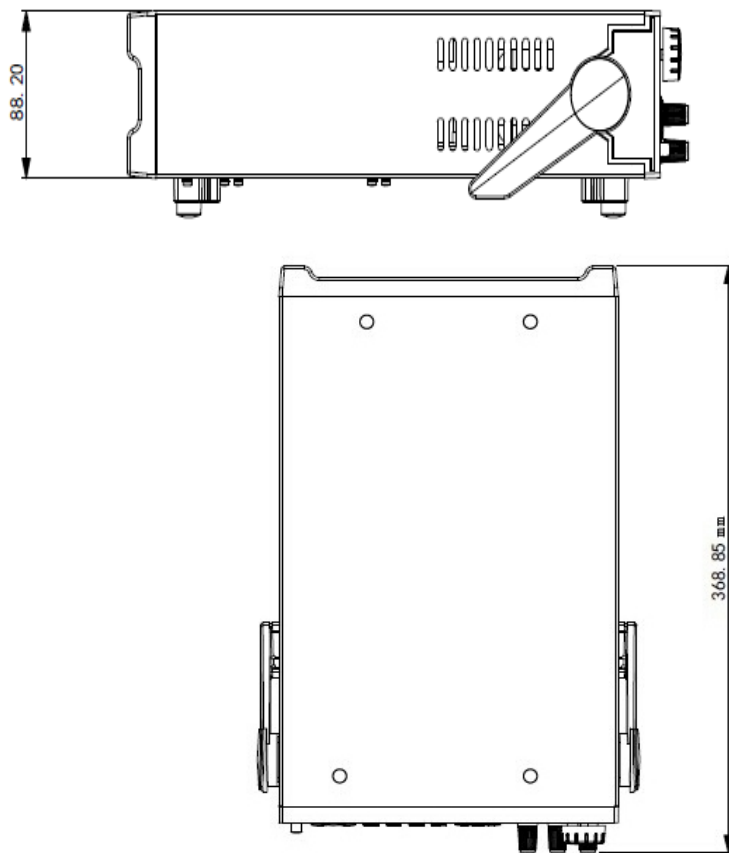

Figure 4: Model 2231A-30-3 top and side dimensions



Adjust the carrying handle

The handle can be adjusted to the position shown in the following figures.

Figure 5: Place the instrument with the handle under the bottom surface

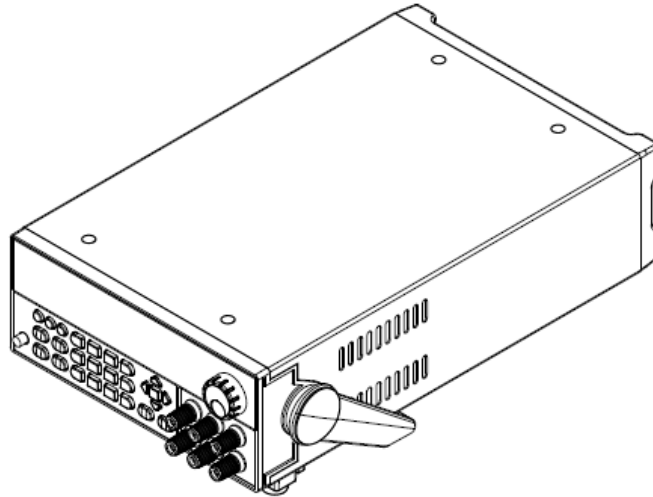

Figure 6: Place the instrument standing on the handle

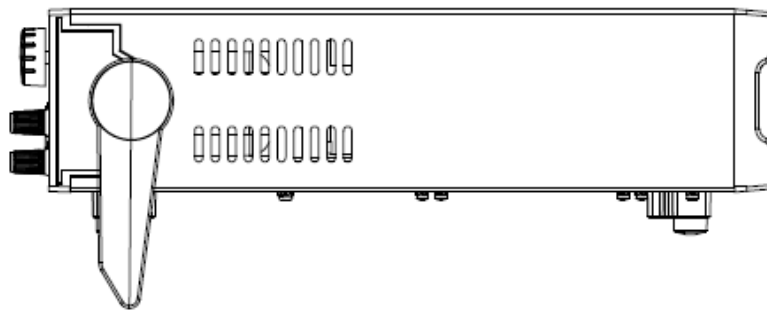
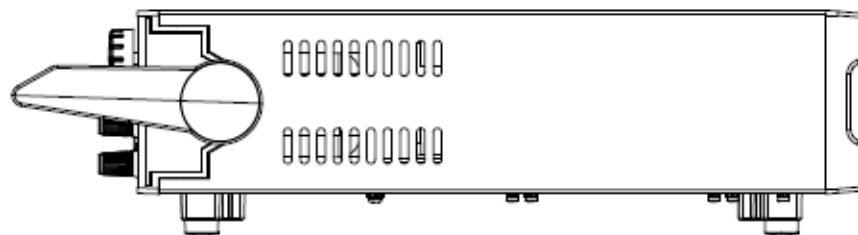

Figure 7: Adjust the handle in front of the front panel



Power the instrument on or off

Follow the procedure below to connect the Model 2231A-30-3 to line power and turn on the instrument. The Model 2231A-30-3 operates on two ranges: 110 V and 230 V at a frequency of 50 Hz or 60 Hz. You need to select the line voltage and frequency on the rear panel. Make sure the line voltage setting is compatible with the line voltage in your area.

The Model 2231A-30-3 must be turned on and allowed to warm up for at least one hour to achieve rated accuracies.

 **WARNING**

The power cord supplied with the Model 2231A contains a separate protective earth (safety ground) wire for use with grounded outlets. When proper connections are made, the instrument chassis is connected to power-line ground through the ground wire in the power cord. In addition, a redundant protective earth connection is provided through a screw on the rear panel. This terminal should be connected to a known protective earth. In the event of a failure, not using a properly grounded protective earth and grounded outlet may result in personal injury or death due to electric shock.

Do not replace detachable mains supply cords with inadequately rated cords. Failure to use properly rated cords may result in personal injury or death due to electric shock.

To connect the power cord:

1. Make sure that the front panel POWER switch is in the off position.
2. Properly set the 110 V/220 V selector switch located on the rear panel.
3. Connect the female end of the supplied power cord to the AC receptacle on the rear panel.
4. Connect the other end of the power cord to a grounded AC outlet.

To turn a Model 2231A-30-3 on and off:

1. Disconnect any devices under test (DUTs) from the Model 2231A-30-3 before turning the instrument on.
2. To turn your instrument on, push the front-panel POWER switch to place it in the on position. The screen is displayed when power up is complete.
3. To turn your instrument off, Push the front-panel POWER switch to place it in the off position.

 **WARNING**

To avoid any fire or electric shock, please ensure the AC input voltage fluctuation does not exceed 10% of the working voltage range.

To satisfy safety requirements, always use load wires heavy enough that they will not overheat when carrying the maximum short-circuit output current of the power supply. If there is more than one load, then every pair of load wires must be capable of safely carrying the full-rated current of the power supply.

Self-test procedure

After the instrument is powered on, the screen displays the following information during the self-test process.



Initializing...

After 1 s, the screen displays the following information for about 2 s if the EEPROM test fails.

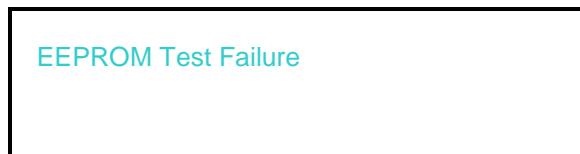

EEPROM Test Failure

If the last saved settings for the power supply are lost, the vacuum fluorescent display displays the following information for 2 seconds:

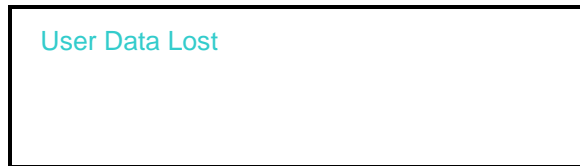

User Data Lost

During the channel scan, the screen displays the following information:

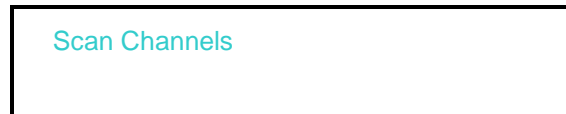

Scan Channels

If the channel data initialization fails, the screen displays the following information for 2 seconds:



Channel Initialization Failed

If the user calibration data in the EEPROM are lost, the screen displays the following information for 2 seconds:

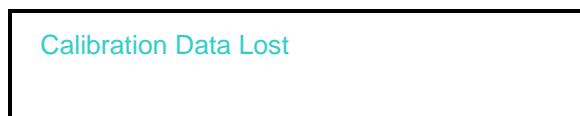

Calibration Data Lost

If the factory calibration data are lost, the screen displays the following information for 2 seconds:



Factory Calibration Data Lost

If no error occurs during the self-test, the screen should display as below: the first row is the output voltage of the 3 channels, and the second row is the current or the OFF status indicator.

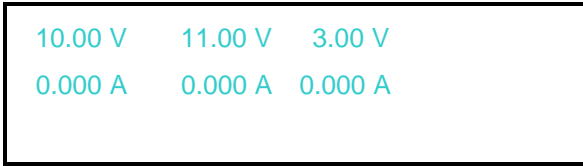

10.00 V	11.00 V	3.00 V
0.000 A	0.000 A	0.000 A

Check the output

The following procedures verify that the power supply outputs its rated voltage and current and properly responds to operations from the front panel.

Voltage output check

To verify basic voltage function without a load, please follow these steps:

1. Remove all leads from the output connectors.
2. Turn on the power supply.
3. Push **Menu**. **Default Set** should appear on the display.
4. Push **Enter** to bring up the default settings menu. **No** and **Yes** should appear on the display.
5. Push the down arrow keys to select **Yes**. Push **Enter** to enable the default settings.
6. Push the front-panel **On/Off** button to turn on the outputs. The **OFF** messages on the display should be replaced by current readings and the **CV** indicators should turn on. The upper line of the display should show the actual output voltage.
7. Check that the front-panel voltmeter properly responds to the number buttons. First, select a channel using one of the channel select buttons. Push **V-set**, use the number buttons to set the voltage value to 0 and push **Enter**. Check if the displayed voltage value is approximately 0 V and check if the displayed current value is approximately 0 A. You can confirm the 0 V setting with a voltmeter.
8. Push **V-set** and use the numeric buttons and **Enter** button to set the voltage value to the maximum allowable for your power supply, as indicated on the unit's front-panel.
9. Check if the displayed voltage value is approximately the same value as the voltage setting.
10. Repeat steps 7 through 9 for each output channel.

Current output check

To verify the basic current functions when the power supply is short-circuited, please follow these steps:

1. Remove all leads from the output connectors.
2. Turn on the power supply.
3. Push **Menu. Default Set** should appear on the display.
4. Push **Enter** to bring up the default settings menu. **No** and **Yes** should appear on the display.
5. Push the down arrow keys to select **Yes**. Push **Enter** to enable the default settings.
6. Ensure that the output is disabled and the **OFF** indicator is shown for all channels. If needed, push the **On/Off** button to ensure that the outputs are disabled and the **OFF** messages are displayed.
7. Use an insulated test lead to connect a short across the (+) and (-) output terminals of the channel you will be testing.
Use a wire size sufficient to handle the maximum current.

WARNING

To satisfy safety requirements, always use load wires heavy enough that they will not overheat when carrying the maximum short-circuit output current of the power supply. If there is more than one load, then every pair of load wires must be capable of safely carrying the full-rated current of the power supply.

8. Push the **On/Off** button to enable the outputs. The **CC** indicator should be on the channel with the shorted output.
9. Select a channel using one of the channel select buttons.
10. Push **I-set** and use the numeric buttons and the **Enter** button to set the current value to 0 A. Check if the displayed current value is approximately 0 A.
11. Push **I-set** and use the numeric buttons and the **Enter** button to set the current value to the maximum allowable for the output channel. Check if the displayed current value is approximately the same value as the maximum allowable.
12. Turn all outputs off by pushing the Output **On/Off** button. Note that the outputs are off when the display for all channels shows **<OFF>**.
13. Repeat steps 7 through 12 for each output channel.
14. Turn off the instrument and remove the short wire from the (+) and (-) output terminals.

What to do if the power supply does not turn on

To solve problems you might encounter when turning on the power supply, please follow these steps:

1. Verify that there is AC power applied to the power supply.

First, check that the AC power cord is firmly plugged in to the power connector on the rear-panel of the power supply. You should also make sure that the AC power source you plugged the power supply in to is energized. Then, check that the power supply is turned on.

2. Verify the power-line voltage setting.

Make sure the voltage selector switch is set according to the present line voltage (110 VAC or 220 VAC) when the power supply is shipped from the factory. Change the voltage setting if it is incorrect.

- 3. Verify the correct power-line fuse is installed.

If the fuse is damaged, please see the table below to replace the fuse for your power supply.

Model	Fuse Specifications
2231A-30-3	3.15 A (220V AC)
	6.30 A (110V AC)

- 4. If you need more help, contact Keithley.

General operation

In this section:

Front-panel operation overview.....	3-1
Panel description.....	3-2
Indicator description.....	3-3
Basic settings.....	3-3
Menu description.....	3-4
Overtemperature protection	3-11

Front-panel operation overview

Within a few seconds after powering on, the power supply shows the actual voltage for each channel on the top line of the display and the actual current for each channel on the bottom line of the display.

You can enable or disable the output of the power supply from the front-panel by pushing the output **On/Off** button. When the output is off, the **OFF** message will appear on the display.

The display shows the present operating status of each channel with display messages. When a channel operates in constant voltage mode, the **CV** indicator is displayed. When it operates in the constant current mode, the **CC** indicator is displayed.

NOTE

To cancel a function operation (**V-set**, **I-set**, **Save**, **Recall**, or **Menu**), push the **Esc** button.

If the front-panel was locked with a password, enter the correct password after you push the function buttons (**V-set**, **I-set**, **Save**, **Recall**, or **Menu**), then you can change the settings.

Panel description

Figure 8: Keyboard

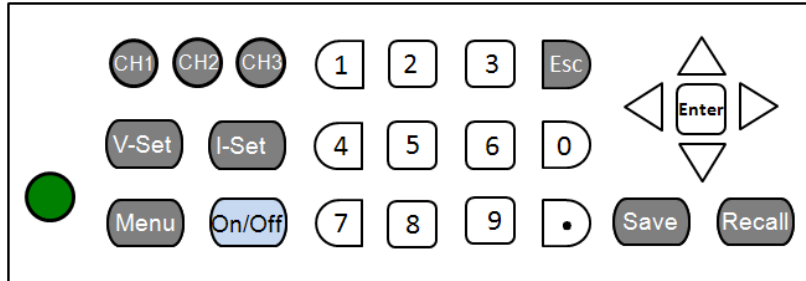

Item	Description
	Select channel 1
	Select channel 2
	Select channel 3
	Set the voltage limit
	Set the current limit
	Open the menu
	Turn on or off all enabled channels. You can enable or disable each using the menu. When turning on the output, the CC or CV indicator is displayed on the screen. When turning off the output, OFF indicator is displayed on the screen.
0 to 9	Numeric buttons
	Return to previous menu level
	Use left/right arrow buttons to move the cursor
	Use up/down arrow keys to adjust the parameters or select the menu operation.
	Save the present instrument settings as a user-saved setup. The Model 2231A-30-3 supports up to 30 setups.
	Return the instrument to the specified setup.
	Select the menu item or confirm the cooperation.

Indicator description

Item	Description
CC	Constant current mode.
CV	Constant voltage mode.
∇	The power supply is in remote control mode.
Series	The outputs of Channel 1 and channel 2 are wired in series.
Para	The outputs of Channel 1 and channel 2 are wired in parallel.
T	Channel 1 and channel 2 are in tracking mode.

Basic settings

Set the voltage output or voltage limit for a specific channel

You may set the voltage limit from 0 V to the maximum voltage rating shown on the instrument nameplate. To set the voltage limit, do the following:

1. The position of the cursor determines which channel will be adjusted. If the cursor is not located on the correct channel, select the correct channel by pushing the appropriate channel select button.
2. Push **V-set**.
3. Use the numeric buttons and push **Enter** to set the voltage limit. You can also use the up, down, right and left arrow buttons.

Set the current output or current limit for a specific channel

You may set the current limit from 0 A to the maximum current value of each model. The maximum current rating is shown on the instrument nameplate. To set the current limit, do the following:

1. The position of the cursor determines which channel will be adjusted. If the cursor is not located in the correct channel, select the correct channel by pushing the appropriate channel select button.
2. Push **I-set**.
3. Use the numeric buttons and push **Enter** to set the current limit. You can also use the up, down, right and left arrow buttons.

Save and recall the setups

You can store up to 30 different setups in memory locations. Each setup includes a voltage limit, current limit and maximum output voltage.

To save the setups:

1. After you set up the power supply, push the **Save** button.
2. Use the number buttons or the arrow buttons to select the setup memory (1 to 30) that you want to store the values in.
3. Push **Enter** to confirm the memory location.

To recall the setups:

1. Push **Recall**.

2. Use the number buttons or the arrow buttons to select the setup memory that you want to recall from.
3. Push **Enter**.

You can also use the following SCPI command to save or recall the setup:

- *SAV
- *RCL

NOTE

Model 2231A-30-3 does not support the save/recall function when channel 1 and channel 2 are wired in series or parallel. Also, if channel 1 and channel 2 are in tracking mode, you cannot save or recall the setup.

Menu description

Push the **Menu** button to enter menu operation. The organization of the menu is shown in the table below.

Menu items		Description
Default Set		Restore the factory default settings
Enable Channels		Enable or disable output channels
Protection Settings		
	Max Volt Set	Set the maximum voltage that can be set. This influences the voltage setting range.
	Output Timers	Set the output timers for each channel. Once the timer expires, the output of the specified channel is turned off.
	Key Lock	Lock the front panel with a password to avoid any improper operation
Track CH1/CH2		Enable or disable the tracking mode
Combine CH1+CH2		Combine the meter readings of channel 1 and channel 2.
User Settings		
	Output Recall	The output status after power on
	Save Last	The voltage, current and max voltage set after power on
	Key Beep	Turn the button beeper on or off
	Knob Lock	Lock the knob
	Baud Rate	Check the baud rate (9600bps)
System Info		
	Error Log	List all errors that occurred
	Main:1.02/Aux:0.01	The firmware version
	Calibrate Date	2014-04-28 16:06:58

Default Set

You can restore the factory default settings by doing the following:

1. Remove all of the leads from the output terminals.
2. Push the Power button to turn on the power supply.
3. Push **Menu**.
4. Push **Enter** to select **Default Set**.
5. Push the down arrow button to select **Yes**.

6. Push **Enter**.

The default settings for the menu selections are as shown below.

Item	Description
Enable Channels	Enable CH1
	Enable CH2
	Enable CH3
Max V CH1	Off
Max V CH2	Off
Max V CH3	Off
Timer CH1	Off
Timer CH2	Off
Timer CH3	Off
Track CH1/CH2	Track Off
Combine CH1+CH2	Combine Off
Output Recall	Off
Save Last	On
Button beep	Off
Knob Lock	Off

Enable Channels

You can enable or disable each output channel using the menu settings. If a channel is disabled, it will remain off after the **Output On/Off** button is turned on. The default setting is to have all channels enabled.

Protection Settings

The protection settings allow you to set the max voltage, the output timers and the front panel button lock for all of the channels.

Set the maximum voltage

This control determines the maximum voltage that you can set using the **V-set** control. This can help prevent accidental overvoltage from being applied to sensitive loads.

To set the maximum voltage, follow these steps:

1. Push **Menu**.
2. Push the down arrow button to select **Protection Settings**.
3. Push **Enter**. **Max Volt Set** should appear on the display.
4. Push **Enter**. A list of Max V settings for each channel will appear.
5. Use the up and down arrow keys to select the correct channel and push **Enter** to confirm.
6. Push the down arrow button to select **On**.
7. Use the numeric buttons or the up/down buttons or the rotary knob to adjust the voltage value. The value must be less than the rated voltage of the power supply.
8. Push **Enter**.
9. Push the **Esc** button to exit the menu.

Set the output timers

Independent timers may be activated and set for each output channel. The timers start when the **Output On/Off** button is turned on. When each active timer expires, its corresponding channel turns off. The timer range is 0.1 to 99999.9 seconds.

Set the key lock status

This function prevents any adjustments from being made to the instrument. Once the lock is activated, a four-digit, user-specified password must be entered to change any instrument settings. But after the front-panel is locked, only the **Output On/Off** button and power button can operate normally. Turning the power off deactivates the lock and resets the password.

To set the button lock status, follow these steps:

1. Push **Menu**.
2. Push the down arrow button and select **Protection Settings**.
3. Push **Enter**. **Max Volt Set** should appear on the display.
4. Push the down arrow to select **Key Lock**.
5. Push **Enter**. You need to enter a four-digit password.
6. Use numeric buttons to input the password and then push **Enter**.

Track CH1/CH2

When tracking is turned on, channel 1 and channel 2 respond together to any adjustments in voltage. A constant ratio will be maintained between the voltage settings on the two channels. The ratio is determined by the voltage settings present on Channel 1 and Channel 2 when tracking is turned on.

For example, if Channel 1 and Channel 2 are both set to 1 V when tracking is turned on, a one to one ratio will be maintained and any voltage change on Channel 1 will result in an identical change on Channel 2. If Channel 1 is set to 10 V and Channel 2 is set to 5 V when tracking is turned on, a two to one ratio will be maintained and any voltage change on Channel 1 will result in a voltage change of half the size of Channel 2.

1. Push **CH1**, then **V-Set**, and then enter the desired voltage for channel 1. For example, set the voltage of channel 1 to 3 V.
2. Push **Enter**.
3. Push **CH2**, then **V-Set**, and then enter a voltage in the desired ratio to channel 1. For example, set voltage of channel 2 to 6 V. The ratio should be 2.
4. Push **Enter**.
5. Push **Menu**, use the down arrow key to navigate to **Track CH1/CH2**, and then push **Enter**.
6. Push the down arrow key to select **Track On** and then push **Enter** to turn on tracking.
7. Check that a **T** shows between the voltage readings of channel 1 and channel 2 on the display. This indicates the power supply is in the tracking mode.

To disable the track function:

1. Push **Menu**.
2. Use the arrow keys to select **Track CH1/CH2**.
3. Push **Enter**.
4. Use the arrow keys to select **Track Off**.
5. Push **Enter**.

NOTE

If the voltage/current is set to 0, then tracking voltage/current is ignored.

If tracking is enabled and CH1 and CH2 timers are both set, then the timer uses the shorter value.

Combine CH1+CH2

You can combine the meter readings of channel 1 and channel 2. The following procedures show you how to combine channels (for example, when outputs are wired in series or in parallel.)

V1+V2 Series

To combine metering of channel 1 and channel when the outputs are wired in series:

Figure 9: Series setup

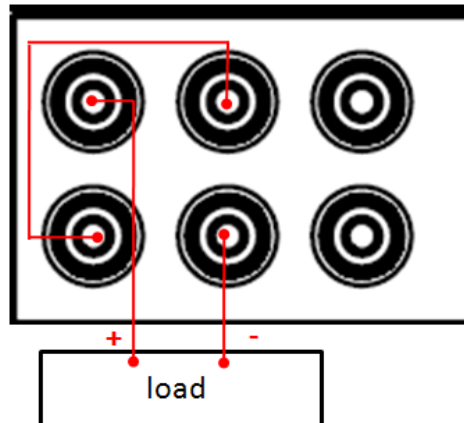
**NOTE**

The wiring between the supplies drives the accuracy of measurements in this mode. Ensure that wire sizes are sufficient, wires are short, and connections are tightened to maximize accuracy.

1. Wire the outputs in series, as shown in the figure above.
2. Push **Menu**.
3. Use the arrow keys to select **Combine CH1+CH2**.
4. Push **Enter**.
5. Push the down arrow key to select **V1+V2 Series**.
6. Push **Enter**. The screen will return to meter mode. Check that the indicator **Series** appears on the display, replacing the Channel 2 voltage and current readings. This indicates that the power supply is in the V1 + V2 Series state. The total output voltage is displayed on Channel 1.
7. Set the channel 1 voltage to the desired voltage value (up to 60 V).

I1+I2 parallel:

To combine metering of channel 1 and channel 2 when the outputs are wired in parallel:

Figure 10: Parallel setup

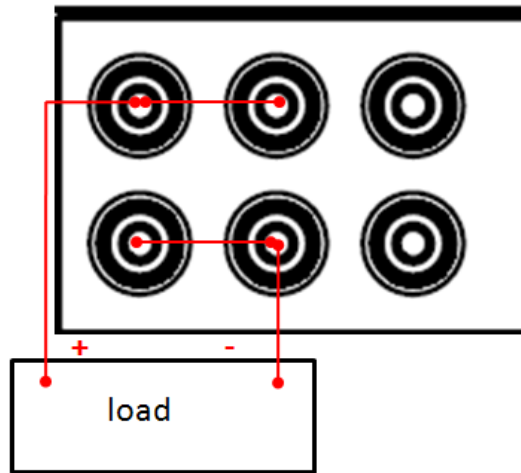
**NOTE**

All measurements are at the terminals. If the wires used to connect the channels together are too small, too long, or improperly tightened, accuracy of measurements will be adversely affected.

1. Wire the outputs in parallel, as shown in the figure above.
2. Push **Menu**.
3. Use the arrow keys to select **Combine CH1+CH2**.
4. Push **Enter**.
5. Push the down arrow key to select **I1+I2 parallel**.
6. Push **Enter**. The screen will return to meter mode. Check that the indicator **Para** appears on the display, replacing the channel 2 voltage and current readings. This indicates that the power supply is in the I1 + I2 state. The total output current is displayed on channel 1.
7. Set channel 1 to the desired current value (up to 6 A).

Combine Off

To turn off the combination of channel 1 and channel 2:

1. Remove all wires connected to the output terminals.
2. Push **Menu**.
3. Use the arrow keys to select **Combine CH1+CH2**.
4. Push **Enter**.
5. Push the down arrow key to select **Combine Off**.
6. Push **Enter**.

Figure 11: Common setup

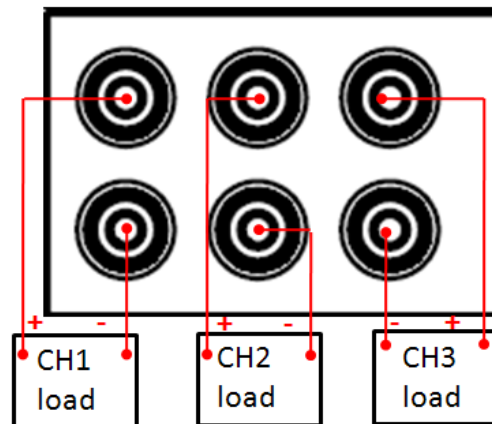

User Settings

Output Recall

This parameter determines the output state when the power supply is powered on. If you select **On** for the output recall function, the power supply will restore the output state to that which was in use before the power was last turned off. If the output was turned on when the power supply is turned off or loses power, then the output will return to the **On** state when the power supply is turned back on or power is restored. If you select **Off** for output recall function, the output channel will always be set to off after the power supply is powered on.

To enable/disable the function:

1. Push **Menu**.
2. Use the arrow keys to select **User settings**.
3. Push **Enter**. The screen will display **Output Recall**.
4. Push **Enter**.
5. Use the arrow keys to select **On** or **Off**.
6. Push **Enter**.
7. Push **Esc** to exit the menu.

Save Last

This item determines whether the power supply saves its most recent settings, such as voltage and current, and restores these settings at power on. If you set this item to **On**, the power supply will restore the instrument to the state that it was in before the power was last turned off. If you select **Off**, then the factory default settings are used (sets voltage to 1V and current to 0A for each channel)

To enable/disable this function:

1. Push **Menu**.
2. Use the arrow keys to select **User settings**.
3. Push **Enter**. The screen will display **Output Recall**.
4. Use the arrow keys to select **Save Last**.
5. Push **Enter**.
6. Use the arrow keys to select **On** or **Off**.
7. Push **Enter**.

8. Push **Esc** to exit the menu.

Key Beep

Turn the instrument key-click sound on or off from this menu.

To enable/disable this function:

1. Push **Menu**.
2. Use the arrow keys to select **User settings**.
3. Push **Enter**. The screen will display **Output Recall**.
4. Push the down arrow keys to select **Key Beep**.
5. Push **Enter**.
6. Use the arrow keys to select **On** or **Off**.
7. Push **Enter**.
8. Push **Esc** to exit the menu.

Knob Lock

Lock the knob so it cannot be used to change settings or to select menu items.

To enable/disable this function:

1. Push **Menu**.
2. Use the arrow keys to select **User settings**.
3. Push **Enter**. The screen will display **Output Recall**.
4. Push the down arrow keys to select **Knob Lock**.
5. Push **Enter**.
6. Use the arrow keys to select **On** or **Off**.
7. Push **Enter**.
8. Push **Esc** to exit the menu.

Baud Rate

Check the baud rate of the serial port. You can only view the baud rate.

To enable/disable this function:

1. Push **Menu**.
2. Use the arrow keys to select **User settings**.
3. Push **Enter**. The screen will display **Output Recall**.
4. Push the down arrow keys to select **Baud Rate**. **9600bps<Read Only>** is displayed on the screen.
5. Push **Enter**.

System Info

System info includes error log, firmware version and calibrate date.

Checking the error log

1. Push **Menu**.
2. Use the arrow keys and navigate to **System Info** and then push **Enter**.
3. Use the arrow keys and navigate to **Error Log** and then push **Enter**. You will see a list of errors that have occurred.
4. Push **Esc** to exit the menu.

Checking the firmware version

1. Push **Menu**.
2. Use the arrow keys and navigate to **System Info** and then push **Enter**.
3. Use the arrow keys and navigate to **Main**. The numbers you see after **Main** and **Aux** are the main firmware version and auxiliary firmware version, respectively.
4. Push **Esc** to exit the menu.

Checking the calibrate date

1. Push **Menu**.
2. Use the arrow keys and navigate to **System Info** and then push **Enter**.
3. Use the arrow keys and navigate to calibrate date (for example: 2014-04-28 16:06:58).
4. Push **Esc** to exit the menu.

Overtemperature protection (OTP)

If the internal temperature of the power supply exceeds 85 °C, the instrument will turn the power off automatically. You can also hear a beeper sound and the display will show **Over temperature**.

Remote communication

In this section:

Communication interface.....	4-1
Model 2231A-001 USB Adapter.....	4-1

Communication interface

The DB9 interface connector on the rear panel of Mode 2231A-30-3 power supply is TTL level, and you need to use a Model 2231A-001 USB adapter to connect DB9 interface with a PC.

Figure 12: Communication interface

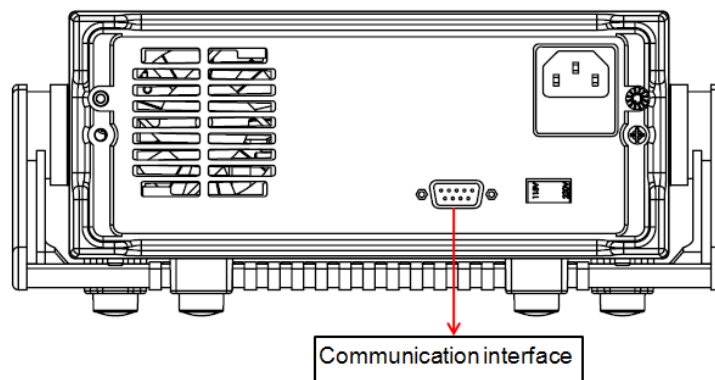

Model 2231A-001 USB Adapter

Figure 13: Model 2231A-001 USB Adapter

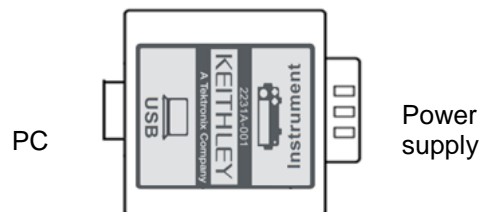

You can use 2231A-001 communication module and a standard USB straight-through cable (one end is B connector, and the other end is A connector) to connect the DB9 interface connector of the power supply to a USB interface.

Figure 13: Communication connection

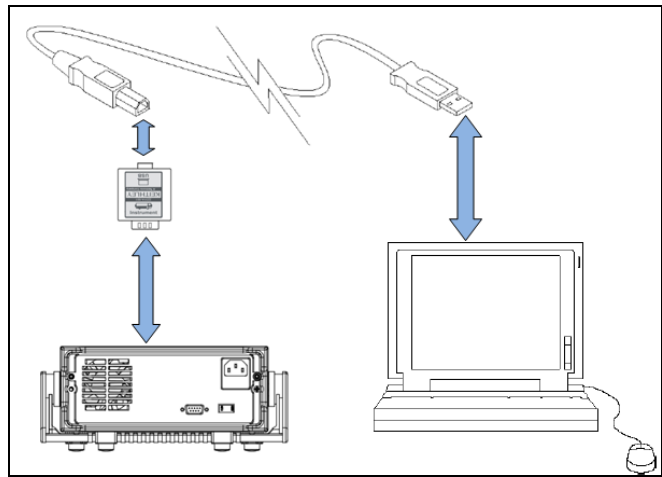

SCPI command reference

In this section:

Common commands.....	5-2
APPLY subsystem.....	5-6
Calibration subsystem.....	5-7
DISPLAY subsystem.....	5-9
INSTrument subsystem	5-10
MEASure subsystem	5-12
OUTPut subsystem.....	5-14
SYSTem subsystem	5-17
STATus subsystem.....	5-19
SOURce subsystem.....	5-24
Status model.....	5-29
Error message	5-31

NOTE

After connecting the 2231A-001 communication connector with PC, you need to send the following command to switch the instrument in remote mode: SYSTem:REMOte.

Common commands

This section describes the general remote interface commands and common commands. The general remote interface commands are commands that have the same general meaning, regardless of the instrument you use.

The common commands perform operations such as reset, wait-to-continue, and status.

Common commands always begin with an asterisk (*) and may include one or more parameters. The command keyword is separated from the first parameter by a blank space.

You can group command messages when you send them to the instrument. Use a semicolon to separate multiple commands, as shown below:

```
*RST; *CLS; *ESE 32; *OPC?
```

Although the commands in this section are shown in uppercase, common commands are not case sensitive (you can either use uppercase or lowercase)

***CLS**

This command clears the event registers and error queues.

Item	Description
Group	System
Syntax	*CLS
Related Commands	*ESE?, *STB?

***ESE**

This command sets or queries the bits in the Event Status Enable Register(ESER). The ESER is an eight-bit register that determines which bits in the Standard Event Status Register (SESR) will set the ESB bit in the Status Byte Register (SBR).

Item	Description
Group	System
Syntax	*ESE <N> *ESE?
Related Commands	*CLS, *SER?

Bit definitions of the standard event register

Bit Position	7	6	5	4	3	2	1	0
Bit Name	PON	Not used	CME	EXE	DDE	QYE	Not used	OPC
Bit Weight	128		32	16	8	4		1
PON	Power-on			DDE	Device-dependent error			
CME	Command error			QYE	Query error			
EXE	Execution error			OPC	Operation complete			

*ESR?

This command reads the value of standard event status register. Once this command executed, the standard event status register is reset. The bit definition for the standard event status register is as the same as the standard event status enable register.

Item	Description
Group	Status
Syntax	*ESR?
Related Commands	*CLS, *OPC

*IDN?

This command reads information about the power supply. It returns a parameter that contains four segments divided by a comma. Example: Keithley instruments, 2231A-30-3, 0123456789ABCDEFGH, 1.01-1.04.

Item	Description
Group	System
Syntax	*IDN?
Related Commands	*CLS, *SER?

*OPC

This command sets the OPC bit in the standard event register to 1 when all other commands are complete.

Item	Description
Group	System
Syntax	*OPC <N> *OPC?
Related Commands	None

*RST

This command is to reset the power supply to default settings.

Item	Description
Group	Status
Syntax	*RST
Related Commands	None

*SRE

This command is to set or query the status byte enable register. Setting this parameter can determine which byte value of the status byte register is 1, and the byte will set the RQS bit of the status byte register to 1. The bit definition of the status byte enable register is as the same as the status byte.

Item	Description
Group	System
Syntax	*SRE <n> *SRE?
Related Commands	*STB?

*STB?

This command is to read the data from status byte register.

Item	Description
Group	Status
Syntax	*STB?
Related Commands	*SER?

Bit definitions for the status byte register:

Bit Position	7	6	5	4	3	2	1	0
Bit Name	OPER	RQS	ESB	MAV	QUES	EAV	no use	no use
Bit Weight	128	64	32	16	8	4		

*TRG

This command initiates a trigger signal when the power supply trigger source is a command from the bus. Its function is the same as the TRIGger command.

Item	Description
Group	Trigger
Syntax	*TRG
Related Commands	*trigger

*SAV

This command is to save the current setups of the power supply into specified memory. These setups contain current, voltage, and the max voltage.

Item	Description
Group	System
Syntax	*sav <NR1>
Arguments	0 to 30
Related Commands	*RCL

*RCL

This command is to recall the setups you saved in the specified memory location.

Item	Description
Group	System
Syntax	*RCL <NR1>
Arguments	0 to 30
Related Commands	*SAV

*TST?

This command is to initialize a self-test and reports any errors.

Item	Description
Group	System
Syntax	*TST
Returns	A return value of 0 means the self-test passes; if there is an error, the error code refers to Table 7

*WAI

This command is to prevent the instrument from executing further commands or queries until all pending commands are complete.

Item	Description
Group	System
Syntax	*WAI
Related Commands	*TRG

*PSC

This command is to set and query the power on status flag that controls the automatic power on status of SRER and ESER.

Item	Description
Group	SOURCE
Syntax	*PSC *PSC?
Related Commands	

APPLY subsystem

The commands in this subsystem set voltage and current levels.

[SOURce:]APPLY

This command is to select channels and set voltage and current levels with a single command.

Item	Description
Group	Apply
Syntax	[SOURce:]APPLY {CH1 CH2 CH3},{voltage Max Min Def Up Down}, {current Max Min Def Up Down} [SOURce:]APPLY?
Arguments	Arg1: CH1 CH2 CH3 Optional Arg2: voltage Max Min Def Up Down Optional Arg3: current Max Min Def Up Down
Returns	Arg1,Arg2,Arg3
Examples	Appl ch1,max,min

[SOURce:]APPLY:VOLTage[:LEVel][:IMMediate][:AMPLitude]

This command is to set voltage to all channels at the same time.

Item	Description
Group	Source
Syntax	[SOURce:]APPLY:VOLTage[:LEVel][:IMMediate][:AMPLitude] [SOURce:]APPLY:VOLTage[:LEVel][:IMMediate][:AMPLitude]?
Arguments	Arg1: voltage setting for CH1 Optional Arg2: voltage setting for CH2 Optional Arg3: voltage setting for CH3

Unit	V
Returns	None
Examples	APP:VOLT 3,3,1

[SOURce:]APPLy:CURRent[:LEVel][:IMMediate][:AMPLitude]

This command is to set current to all channels at the same time.

Item	Description
Group	Source
Syntax	[SOURce:]APPLy:CURRent[:LEVel][:IMMediate][:AMPLitude] [SOURce:]APPLy:CURRent[:LEVel][:IMMediate][:AMPLitude]?
Arguments	Arg1: current setting for CH1 Optional Arg2: current setting for CH2 Optional Arg3: current setting for CH3
Unit	A
Returns	None
Examples	APP:CURR 1,1,0.6

CALibration subsystem

The commands in this subsystem configure and control the calibration operations.

CALibration:SECure:[STATe]

This command clears all the specified strings and returns the display back to voltage and current readings.

Item	Description
Group	Calibration
Syntax	CALibration:SECure:[STATe] {<ON OFF>,<password>} CALibration:SECure:STATe?
Arguments	0 1 ON OFF, '2231'
Returns	0 1
Examples	CAL:SEC 0, '2231'; CAL:SEC OFF

CALibrate:VOLTage:LEVel

This command is to set the voltage calibration points. P1, P2, P3 and P4 must be calibrated in numeric order.

Item	Description
Group	Calibration
Syntax	CALibrate:VOLTage:LEVel <level>
Argument	P1 P2 P3 P4
Returns	None
Examples	Cal:volt:lev P1

CALibrate:VOLTage[:DATA] <numeric value>

This command is to return the actual output voltage value of the calibration point.

Item	Description
Group	Calibration
Syntax	CALibrate:VOLTage[:DATA] <NRf>
Argument	Voltage level
Returns	<NRf>
Examples	CAL:VOLT 30.0002V

CALibrate:CURRent:LEVel

This command is to set the current calibration points. P1, P2 must be calibrated in numeric order.

Item	Description
Group	Calibration
Syntax	CALibrate:CURRent:LEVel <level>
Arguments	P1 P2
Returns	<NRf>
Examples	Cal:curr P1

CALibrate:CURRent[:DATA] {<numeric value>}

This command is to return the actual output current value of the calibration point.

Item	Description
Group	Calibration
Syntax	CALibration:CURRent [:DATA] <NRf>
Arguments	Current level
Item	Description
Returns	None
Examples	CAL:CURR 3.0002A

CALibration:SAVe

This command is to save calibration coefficient into nonvolatile memory.

Item	Description
Group	Calibration
Syntax	CALibration:SAVe
Arguments	None
Returns	None
Examples	Cal:sav

CALibration:INITial

This command is to set the current calibration coefficient as the default value.

Item	Description
Group	Calibration
Syntax	CALibration:INITial
Arguments	None
Returns	None
Examples	Cal:init

CALibrate:STRing

This command is to write or query the calibration information of the instrument.

Item	Description
Group	Calibration
Syntax	CALibration:STRing <string> CALibrate:STRing?
Arguments	char (22 character maximum)
Returns	String
Examples	Cal:str "march 2014"

DISPlay subsystem

This subsystem contains commands that control the front-panel display.

DISPlay[:WINDow][:STATe]

This command is to set or query the state of the instrument display. A value of 0 indicates no display.

Item	Description
Group	Display
Syntax	DISPlay[:WINDow][:STATe] <Arguments> DISPlay[:WINDow][:STATe]?
Arguments	0 1 ON OFF
Returns	0 1
Examples	DISP 0

DISPlay[:WINDow]:TEXT[:DATA]

This command shows a specified string on the screen or queries the screen display.

Item	Description
Group	Display
Syntax	DISPlay[:WINDow]:TEXT[:DATA] <String> DISPlay[:WINDow]:TEXT[:DATA]?
Arguments	String with “ ”
Returns	None
Examples	Disp:text “hello keithley”

DISPlay[:WINDow]:TEXT:CLEAr

This command is to clear all the specified display strings and return the display to voltage and current readings.

Item	Description
Group	Display
Syntax	DISPlay[:WINDow]:TEXT:CLEAr
Arguments	None
Returns	None
Examples	Disp:text:cle

INSTrument subsystem

The commands in this subsystem configure and control the channel selection operations.

INSTrument[:SELEct]

This command is to select the channel.

Item	Description
------	-------------

Group	Channel
Syntax	INSTrument[:SElect] {CH1 CH2 CH3} INSTrument[:SElect]?
Arguments	CH1 CH2 CH3
Returns	CH1/CH2/CH3
Examples	Inst CH2

INSTrument:NSElect

This command is to select the channel.

Item	Description
Group	Channel
Syntax	INSTrument:NSElect <NR1> INSTrument:NSElect?
Arguments	Arg 1, Arg 2, Arg 3
Returns	channel 1, channel 2, and channel 3
Examples	INST:NSEL 3

INSTrument:COMbine:SERies

This command is to combine the voltage reading of CH1 and CH2 when they are connected in a series.

Item	Description
Group	Channel
Syntax	INSTrument:COMbine:SERies
Arguments	None
Returns	None
Examples	Inst:com:ser

INSTrument:COMbine:PARAllel

This command is to combine the current reading of CH1 and CH2 when they are connected in parallel.

Item	Description
Group	Channel
Syntax	INSTrument:COMbine:PARAllel
Arguments	None
Returns	None
Item	Description
Examples	Inst:com:ser

INSTrument:COMbine:TRACk

This command is to set CH1 and CH2 in track mode.

Item	Description
Group	Channel
Syntax	INSTrument:COMbine:TRACk
Arguments	None
Returns	None
Examples	Inst:com:trac

INSTrument:COMbine:OFF

This command is to turn off series/parallel/tracking modes.

Item	Description
Group	Channel
Syntax	INSTrument:COMbine:OFF INSTrument:COMbine:OFF
Arguments	None
Returns	NONE/SERIES/PARALLEL/TRACK
Examples	Inst:com:off

INSTrument:COUPlE[:TRIGger]

This command is to determine which channels will respond to the trigger command.

Item	Description
Group	Channel
Syntax	INSTrument:COUPlE[:TRIGger] <Arguments> INSTrument:COUPlE[:TRIGger]? <Arguments>
Arguments	CH1 CH2 CH3
Returns	None
Examples	Inst:coup ch1.ch2

MEASure subsystem

These commands make measurements.

MEASure[:SCALar]:VOLTage[:DC]?**FETCh[:VOLTage][:DC]?**

The first command is to initiate and execute a new measurement of the voltage.

The second command is to query the current voltage.

Item	Description
Group	Measure
Syntax	MEASure[:SCALar]:VOLTage[:DC]?
Arguments	None
Returns	<NR2> is the new measured voltage with the unit V
Examples	MEAS:VOLT?

MEASure[:SCALar]:CURRent[:DC]?**FETCh:CURRent[:DC]?**

This first command is to initiate and execute a new current measurement.

The second command is to query the current reading.

Item	Description
Group	Measure
Syntax	MEASure[:SCALar]:CURRent[:DC]? FETCh:CURRent[:DC]?
Arguments	None
Returns	<NR2> is the current value in unit A
Examples	MEAS:CURR?

MEASure[:SCALar]:POWer[:DC]?**FETCh:POWer[:DC]?**

This first command is to initiate and execute a new power measurement.

The second command is to query the current power.

Item	Description
Group	Measure
Syntax	MEASure[:SCALar]:POWer? FETCh:POWer[:DC]?
Item	Description

Arguments	None
Returns	<NR2>is the power value in unit W
Examples	MEAS:POW?

OUTPut subsystem

The output subsystem provides information and settings that control the source output.

OUTPut[:STATe][:ALL]

This command is to set the output state of all three channels.

Item	Description
Group	Output
Syntax	OUTPut [:STATe] <bool> OUTPut:STATe[:ALL]?
Arguments	0 1 ON OFF
Returns	0 1
Examples	Outp 1

CHANnel:OUTPut[:STATe]

This command is to control the output status of the current channel.

Item	Description
Group	Output
Syntax	CHANnel:OUTPut[:STATe] <bool> [SOURce:]CHANnel:OUTPut[:STATe]?
Arguments	0 1 ON OFF
Returns	0 1
Examples	Chan:outp 1

OUTPut:ENABLE

This command enables or disables the current output function that was selected in the Enable Channels menu.

Item	Description
Group	Output
Syntax	OUTPut:ENABLE
Item	Description

Arguments	0 1
Returns	0 1
Examples	Outp:enab 1

OUTPut:TIMer[:STATe]

This command is to set the output timer state for the presently selected channel.

Item	Description
Group	Output
Syntax	OUTPut:TIMer[:STATe] <bool> <Arguments> OUTPut:TIMer:STATe?
Arguments	0 1 ON OFF
Returns	0 1
Examples	Outp:tim 1

OUTPut:TIMer:DELay

This command is to set the delay time for the output timer function.

Item	Description
Group	Output
Syntax	OUTPut:TIMer:DELay <Arguments> OUTPut:TIMer:DELay?
Arguments	0.1-99999.9
Unit	s (seconds)
Returns	The timer delay
Examples	Outp:tim:del 5 Outp:tim:del?

OUTPut:TRACk[:STATe]

This command is to set the tracking status of CH1 and CH2.

Item	Description
Group	Output
Syntax	OUTPut:TRACk[:STATe] <bool> [SOURce:]OUTPut:TRACk[:STATe]?
Arguments	0 1 ON OFF
Returns	0 1
Item	Description

Examples	Outp:trac 1
----------	-------------

OUTPut:SERies[:STATe]

This command is to combine the CH1 and CH2 voltage readings when CH1 and CH2 connected in parallel.

Item	Description
Group	Output
Syntax	OUTPut:SERies[:STATe] <Arguments> OUTPut:SERies[:STATe]?
Arguments	0 1 ON OFF
Returns	0 1
Examples	Outp:ser 0 Outp:ser?

OUTPut: PARallel [:STATe]

This command is to combine the CH1 and CH2 current readings when CH1 and CH2 are wired in parallel connection.

Item	Description
Group	Output
Syntax	OUTPut: PARallel [:STATe] <Arguments> OUTPut: PARallel [:STATe]?
Arguments	0 1 ON OFF
Returns	0 1
Examples	Outp:para 1

SYSTem subsystem

This subsystem contains commands that affect the overall operation of the instrument, such as autozero, beeper, communications, event logs, and time.

SYSTem:ERRor?

This command is to query the error code and error information occurring in the power supply.

Item	Description
Group	System
Syntax	SYSTem:ERRor?
Arguments	None
Returns	Both the error code and the error information
Examples	Syst:err?

SYSTem:VERSion?

This command is to query the SCPI version of the instrument.

Item	Description
Group	System
Syntax	SYSTem:VERSion?
Arguments	None
Returns	<NR2> is the SCPI version of the power supply
Examples	Syst:vers?

SYSTem:REMOte

This command is to switch the power supply into remote control mode.

Item	Description
Group	System
Syntax	SYSTem:REMOte
Arguments	None
Returns	None
Examples	syst:rem

SYSTem:LOCal

This command is to switch the power supply into control from the front panel.

Item	Description
Group	System
Syntax	SYSTem:LOCal
Arguments	None
Returns	None
Examples	Syst:loc

SYSTem:RWLock

This command is to switch the power supply into remote control mode and locks all of the buttons on the front panel.

Item	Description
Group	System
Syntax	SYSTem:RWLock
Arguments	None
Returns	None
Examples	SYST:RWL

SYSTem:MODUle?

This command is to query the module of the power supply.

Item	Description
Group	System
Syntax	SYSTem:MODUle?
Arguments	None
Returns	The module of the power supply, for example 2231,1.04
Examples	Syst:modu?

SYSTem:BEEPer

This command is to test the beeper function of the power supply. If it passes, a beep is issued.

Item	Description
Group	System
Syntax	SYSTem:BEEPer
Arguments	None
Returns	None
Examples	Syst:beep

STATus subsystem

The STATus subsystem controls the status registers of the Model 2231A-30-3.

STATus:QUEStionable[:EVENT]?

This command is to return to the contents of the questionable event register. After this command executed, the questionable event register is reset.

Item	Description
Group	Status
Syntax	STATus:QUEStionable[:EVENT]?
Arguments	None
Returns	<NR1> is a decimal integer representation of the contents of the questionable event register. Range: 0 to 255
Examples	Stat:ques?

STATus:QUEStionable:ENABLE

This command is to set and query the contents of the questionable event enable register, The QENR is an eight-bit mask register that determines which bits in the questionable event register should affect the state of QUES bit in the status byte register.

Item	Description
Group	Status
Syntax	STATus:QUEStionable:ENABLE <NR1> STATus:QUEStionable:ENABLE?
Arguments	<NR1> is a decimal integer ranging from 0 to 255, according to which bits of the mask register of the QENR are set.
Returns	<mask>
Examples	Stat:ques:enab?

STATus:QUEStionable:CONDition?

This command is to query the questionable condition register.

Item	Description
Group	Status
Syntax	STATus:QUEStionable: CONDition?
Arguments	None

Returns	<NR1>
Examples	Stat:ques:cond?

STATus:PRESet

This command is to reset the status register.

Item	Description
Group	Status
Syntax	STATus:PRESet
Arguments	None
Returns	None
Examples	Stat:pres

STATus:QUEStionable:INSTrument[:EVENT]?

This command is to query the questionable instrument status event register of the instrument.

Item	Description
Group	Status
Syntax	STATus:QUEStionable:INSTrument[:EVENT]?
Arguments	None
Returns	<NR1> is a decimal integer representation of the contents of the questionable event register. Range: 0~255
Examples	Stat:ques:inst?

STATus:QUEStionable:INSTrument:ENABLE

This command is to query the questionable instrument status event register of the power supply.

Item	Description
Group	Status
Syntax	STATus:QUEStionable:INSTrument:ENABLE STATus:QUEStionable:INSTrument:ENABLE?
Arguments	0~255
Returns	<NR1> is a decimal integer ranging from 0 to 255, according to which the bits of the mask register of the questionable register for the specified channel are set.
Examples	Stat:ques:inst:enab?

STATus:QUEStionable:INSTrument:ISUMmary<x>[:EVENT]?

This queries the operation event register of channel 1, channel 2, channel 3, where <x> is 1, 2 or 3.

Item	Description
Group	Status
Syntax	STATus:QUEStionable:INSTrument:ISUMmary<x>[:EVENT]?
Arguments	None
Returns	<NR1> is a decimal integer representation of the contents of the questionable event register for channel 1, channel 2, channel 3, range: 0 to 255
Examples	Stat:ques:inst:isum1?

STATus:QUEStionable:INSTrument:ISUMmary<X>:ENABLE

This command is to modify or query the operation enable register summary of channel 1, channel 2, channel 3, where <x> indicates 1, 2 or 3.

Item	Description
Group	Status
Syntax	STATus:QUEStionable:INSTrument:ISUMmary<X>:ENABLE STATus:QUEStionable:INSTrument:ISUMmary<X>:ENABLE?
Arguments	<NR1> is a decimal integer representation of the bits of the mask register of the questionable enable register of channel 1, channel 2, and channel 3 (ranging from 0 to 255).
Returns	Same as arguments, 0 to 255
Examples	Stat:ques:inst:isum2:enab 12 Stat:ques:inst:isum2:enab?

STATus:QUEStionable:INSTrument:ISUMmary<x>:CONDition?

This command queries the questionable condition register summary of a channel (1, 2, or 3), where <x> is 1, 2 or 3.

Item	Description
Group	Status
Syntax	STATus:QUEStionable:INSTrument:ISUMmary<x>:CONDition?
Arguments	None
Returns	<NR1> is a decimal integer representation of the contents of the questionable condition register. Range: 0 to 255.
Examples	Stat:ques:inst:isum2:cond?

STATus:OPERation[:EVENT]?

This command is to query the content of the operation event register.

Item	Description
Group	STATus
Syntax	STATus:OPERation [:EVENT]?
Arguments	None
Returns	0~255
Examples	Stat:oper?

STATus:OPERation:CONDition?

This command is to query the contents of the operation condition register.

Item	Description
Group	Status
Syntax	STATus:OPERation:CONDition?
Arguments	None
Returns	0~255
Examples	Stat:oper:cond?

STATus:OPERation:ENABLE

This command is to set or query the contents of the operation enable register.

Item	Description
Group	Status
Syntax	STATus:OPERation:ENABLE <NRf> STATus:OPERation:ENABLE?
Arguments	0~255
Returns	0~255
Examples	Stat:oper:enab?

STATus:OPERation:INSTrument[:EVENT]?

This command is to return to the contents of the operation event register. After this command is sent, the operation event register is reset.

Item	Description
Group	Status
Syntax	STATus:OPERation:INSTrument[:EVENT]?
Arguments	None
Returns	0 to 255
Examples	Stat:oper:inst?

STATus:OPERation:INSTrument:ENABLE

This command is to set or query the contents of the operation instrument enable register.

Item	Description
Group	Status
Syntax	STATus:OPERation:INSTrument:ENABLE STATus:OPERation:INSTrument:ENABLE?
Arguments	0~255
Returns	0~255
Examples	Stat:oper:inst:enab?

STATus:OPERation:INSTrument:ISUMmary<x>[:EVENT]?

This command is to query the operation event register summary of a channel.

Item	Description
Group	Status
Syntax	STATus:OPERation:INSTrument:ISUMmary<x>[:EVENT]?
Arguments	None
Returns	0~255
Examples	Stat:oper:inst:isum2?

STATus:OPERation:INSTrument:ISUMmary<x>:ENABLE

This command is to modify or query the operation enable register of channel 1, 2 or 3, where <x> is 1, 2 or 3.

Item	Description
Group	Status
Syntax	STATus:OPERation:INSTrument:ISUMmary<x>:ENABLE STATus:OPERation:INSTrument:ISUMmary<x>:ENABLE?
Arguments	0~255
Returns	0~255
Examples	Stat:oper:inst:isum3:enab?

STATus:OPERation:INSTrument:ISUMmary<x>:CONDition?

This command is to query the operation condition register of channel 1/2/3.

Item	Description
Group	Status

Syntax	STATus:OPERation:INSTrument:ISUMmary<x>:CONDition?
Arguments	None
Returns	0~255
Examples	Stat:oper:inst:isum1:cond?

SOURce subsystem

The commands in the SOURce subsystem configure and control the current source and voltage source.

[SOURce:]CHANnel:OUTPut[:STATe]

This command is to set the output state of the currently selected channel.

Item	Description
Group	Source
Syntax	[SOURce:]CHANnel:OUTPut[:STATe] [SOURce:]CHANnel:OUTPut[:STATe]?
Arguments	0 1 ON OFF
Returns	0 1
Examples	Chan:outp 1 Chan:outp?

[SOURce:]CURRent[:LEVel][:IMMediate][:AMPLitude]

This command is to set or query the current value for the present channel.

Item	Description
Group	Source
Syntax	[SOURce:]CURRent[:LEVel] <NRf> [SOURce:]CURRent[:LEVel][:IMMediate][:AMPLitude]?
Arguments	MIN TO MAX MIN MAX UP DOWN DEF
Unit	A mA
Returns	<NR2> is the current setting
Examples	Curr 2 Curr?

[SOURce:]CURRent[:LEVel]:UP[:IMMediate][:AMPLitude]

This command is to increase the current value by one step. Set the current step using the command:

[SOURce:]CURRent[:LEVel][:IMMediate]:STEP[:INCRement]

Item	Description
Group	Source
Syntax	[SOURce:]CURRent[:LEVel]:UP[:IMMediate][:AMPLitude]
Arguments	None
Returns	None
Examples	Curr:up

[SOURce:]CURRent[:LEVel]:DOWN[:IMMediate][:AMPLitude]

This command is to decrease the current value by one step.

Item	Description
Group	Source
Syntax	[SOURce:]CURRent[:LEVel]:DOWN[:IMMediate][:AMPLitude]
Arguments	None
Returns	None
Examples	Curr:down

[SOURce:]CURRent[:LEVel][:IMMediate]:STEP[:INCRement]

This command is to set the current stepping.

Item	Description
Group	Source
Syntax	[SOURce:]CURRent[:LEVel][:IMMediate]:STEP[:INCRement] [SOURce:]CURRent[:LEVel][:IMMediate]:STEP[:INCRement]?
Arguments	Current value
Unit	A mA Ua
Returns	Current value
Examples	Curr:step 0.1 Curr:step?

[SOURce:]CURRent[:LEVel]:TRIGgered[:IMMediate][:INCRement]

This command is to set or query the current level for the trigger function. When you set the trigger voltage and current and send the trigger command to the instrument, the voltage and current will change to the trigger voltage and current that you set.

Item	Description
Group	Source
Syntax	[SOURce:]CURRent[:LEVel]:TRIGgered[:IMMediate][:INCRement]

	[SOURce:]CURRent[:LEVel]:TRIGgered[:IMMediate][:INCRement]?
Arguments	Current value Min Max Def Up Down
Returns	Current value
Examples	Curr:trig 1

[SOURce:]VOLTage[:LEVel][:IMMediate][:AMPLitude]

This command is to set the voltage value for the current output.

Item	Description
Group	Source
Syntax	[SOURce:]VOLTage[:LEVel] <NRf> [SOURce:]VOLTage[:LEVel]?
Arguments	MIN TO MAX MIN MAX UP DOWN DEF
Unit	V mV KV
Returns	<voltage>
Examples	Volt 19

[SOURce:]VOLTage[:LEVel]:UP[:IMMediate][:AMPLitude]

This command is to increase the voltage level by one step; the value of the step value also can be set by this command.

Item	Description
Group	Source
Syntax	[SOURce:]VOLTage[:LEVel]:UP[:IMMediate][:AMPLitude]
Arguments	None
Returns	None
Examples	Volt:up

[SOURce:]VOLTage[:LEVel]:DOWN[:IMMediate][:AMPLitude]

This command is to decrease the voltage level by one step.

Item	Description
Group	Source
Syntax	[SOURce:]VOLTage[:LEVel]:DOWN[:IMMediate][:AMPLitude]
Arguments	None
Returns	None
Examples	Volt:down

[SOURce:]VOLTage[:LEVel][:IMMediate]:STEP[:INCRement]

This command configures voltage stepping.

Item	Description
Group	Source
Syntax	[SOURce:]VOLTage[:LEVel][:IMMediate]:STEP[:INCRement] <voltage> [SOURce:]VOLTage[:LEVel][:IMMediate]:STEP[:INCRement]?
Arguments	The voltage step for UP/DOWN adjustment
Unit	kV V mV uV
Returns	None
Examples	Volt:step 0.01 Volt:step?

[SOURce:]VOLTage[:LEVel]:TRIGgered[:IMMediate][:INCRement]

This command is to set the level for the trigger function. When you set the trigger voltage and current and send the trigger command to the instrument, the voltage and current can switch to the trigger voltage and current that you set before.

Item	Description
Group	Source
Syntax	[SOURce:]VOLTage[:LEVel]:TRIGgered[:IMMediate][:INCRement] [SOURce:]VOLTage[:LEVel]:TRIGgered[:IMMediate][:INCRement]?
Arguments	0 to max rated voltage
Unit	kV V mV uV
Returns	Trigger voltage
Examples	Volt:trig 12

[SOURce:]VOLTage:LIMIT[:LEVel]

This command is to set the voltage limit for the present channel.

Item	Description
Group	Source
Syntax	[SOURce:]VOLTage:LIMIT[:LEVel] [SOURce:]VOLTage:LIMIT[:LEVel]?
Arguments	0 to max rated voltage Min Max def
Returns	The voltage limit

Examples	Volt:limit 25
----------	---------------

[SOURce:]VOLTage:LIMit:STATe

This command is to enable or disable the voltage limit function.

Item	Description
Group	Source
Syntax	[SOURce:]VOLTage:LIMit:STATe <bool> [SOURce:]VOLTage:LIMit:STATe?
Arguments	1 0(1:enable)
Returns	The voltage limit
Examples	Volt:limit 25

Status model

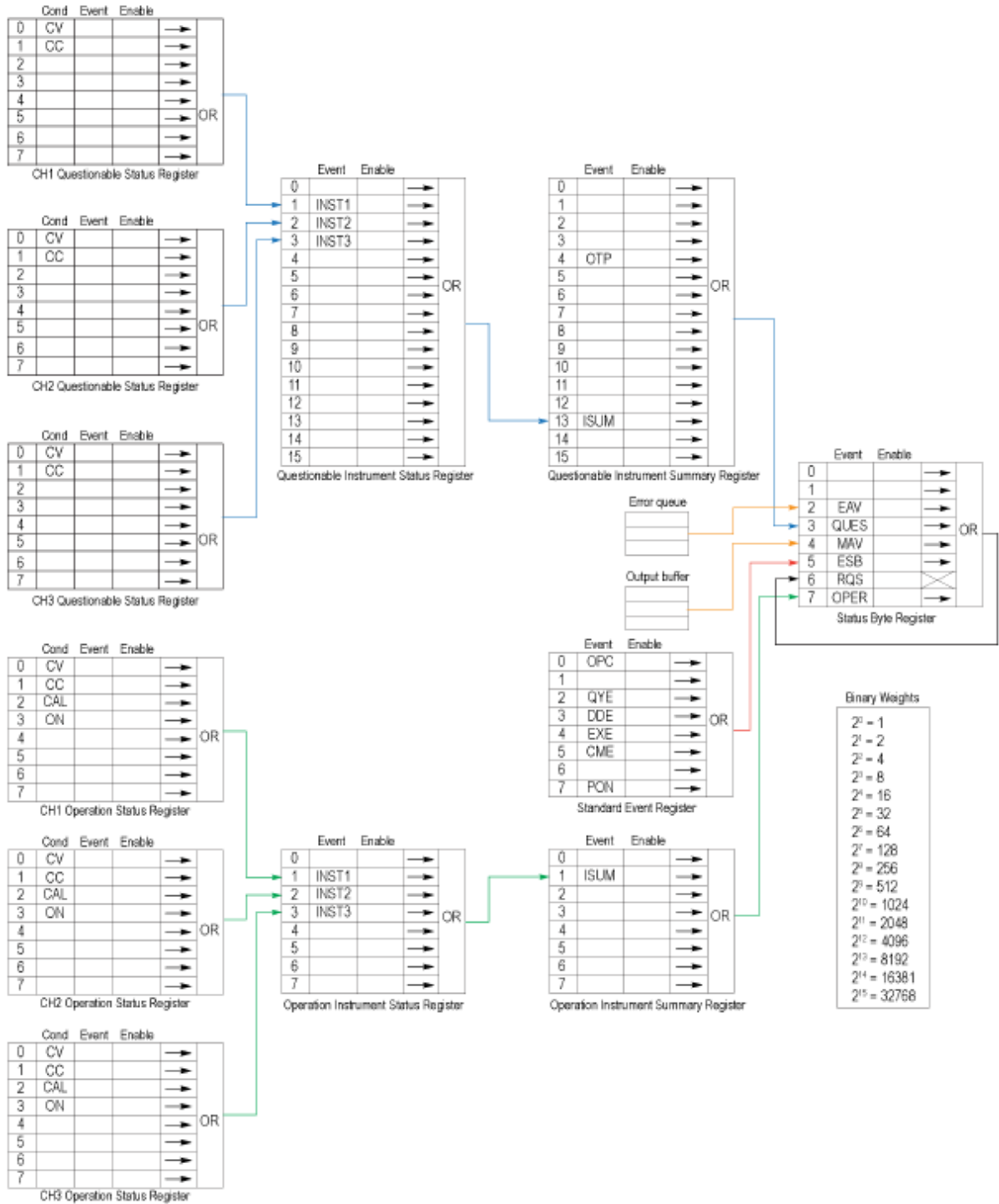

BIT	Signal	Meaning
0	CV	Operation Instrument Summary Register Constant voltage
1	CC	Constant current
2	CAL	The power supply is calculating the new calibration parameter.
3	ON	The output of the power supply is ON or OFF.
1	INST1	Operation Instrument Status Register STATus:OPERation:INSTrument:ISUMmary1 is reported to INST1
2	INST2	STATus:OPERation:INSTrument:ISUMmary2 is reported to INST2
3	INST3	STATus:OPERation:INSTrument:ISUMmary3 is reported to INST3
1	ISUM	Operation status register Summary of STAT:OPER:INST
0	CV	Questionable Instrument Summary Register Constant voltage
1	CC	Constant current
1	INST1	Questionable Instrument status Register STATus:QUEStionable:INSTrument:ISUMmary1 is reported to INST1
2	INST2	STATus:QUEStionable:INSTrument:ISUMmary2 is reported to INST2
3	INST3	STATus:QUEStionable:INSTrument:ISUMmary3 is reported to INST3
4	OTP	Questionable Status Register Over temperature protection
13	ISUM	Summary of STAT:QUES:INST
0	OPC	Standard Event Register Operation complete.
2	QYE	Query error. Data for output array is missing.
3	DDE	Device-dependent error. Data stored in the register is missing or the error occurs in preliminary checkout.
4	EXE	Execution error. The command parameter overflows or the condition is not right.
5	CME	Command error. Syntax or semantic error occurs when receiving information.
7	PON	Power on. The value is 1 when the power supply is reset.
2	EAV	Status Byte Register Error buffer is available
3	QUES	If the questionable status register changes, QUES is 1.
4	MAV	Output buffer is available
5	ESB	If the standard event enable register changes, ESB is 1.
6	RQS	
7	OPER	If the operation status register changes, OPER is 1.

Error messages

Code	Description
0	'No Error'
1	'Module Initialization Lost'
2	'Initialization Lost'
3	'Module Calibration Lost'
4	'Eeprom failure'
101	'Too many numeric suffices'
110	'No input command'
114	'Error Para Units'
116	'Error Para Type'
117	'Error Para Count'
120	'Unmatched Quote'
140	'Unmatched Bracket'
150	'Invalid Command'
160	'No Entry'
165	'Too Many Dims'
170	'Too Many Commands'
180	'Command Exec Err'
190	'Error Rxd Parity'
191	'Error EEPROM'
121	'Error Config Data'
122	'Error Cal. Data'
123	'Error Factory Data'
170	'Invalid command'
180	'No entry in list'
190	'Too many dimensions'
191	'Too many char'
-200	'Execution error'
-221	'Settings conflict'
-222	'Data out of range'

Code	Description
-223	'Too much data'
-224	'Illegal parameter value'
-225	'Out of memory'
-230	'Data Corrupt or Stale'
-310	'System error'
-350	'Too many errors'
-400	'Query error'
-410	'Query INTERRUPTED'
-420	'Query UNTERMINATED'
-430	'Query DEADLOCKED'
223	'Front panel buffer overrun'
224	'Front panel timeout'
225	'Front Crc Check error'
401	'CAL switch prevents'
402	'CAL password is incorrect'
403	'CAL not enabled'
404	'readback cal are incorrect'
405	'programming cal are incorrect'

Additional Information

In this section:

[Additional Model 2231A-30-3 information.....6-1](#)

Additional Model 2231A-30-3 information

For more information about the Model 2231A-30-3, refer to:

- The Product Information CD-ROM (shipped with the product) contains the product documentation.
- The Keithley Instruments website (<http://www.keithley.com>) contains the most up-to-date information. From the website, you can access:
 - The Knowledge Center, which contains the following handbooks:
 - *The Low Level Measurements Handbook: Precision DC Current, Voltage, and Resistance Measurements*
 - *Switching Handbook: A Guide to Signal Switching in Automated Test Systems*
 - Application notes
 - Updated drivers
 - Updated firmware
- Your local Field Applications Engineer, sales partner, or distributor. They can help you with product selection, configuration, and usage. Check the website for contact information.

In this appendix:

Introduction A-1
 Line fuse replacement A-1
 Cleaning the front-panel display A-2

Introduction

The information in this section describes routine maintenance of the instrument that can be performed by the operator.

Line fuse replacement

On the back panel, you will find a small plastic cover below the power supply.

NOTE

Make sure that the replacement fuse meets the specifications of the power supply.

Model	110 V	220 V
2231A-30-3	6.30 A TH 250V	3.15 A TH 250V

To replace the line fuse replacement, follow these steps:

1. Open the cover with a screwdriver.
2. Remove the power cord.
3. Use a screwdriver to remove the fuse box.

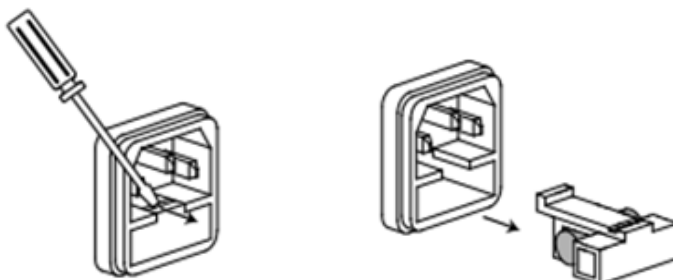

4. Replace the fuse with a new fuse with the same ratings as the fuse you are removing; install it into the fuse box and then insert the box cover.

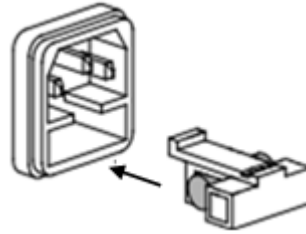

⚠ WARNING

Disconnect the line cord at the rear panel and remove all test leads connected to the instrument before replacing the line fuse. Failure to do so could expose the operator to hazardous voltages that could result in personal injury or death.

Cleaning the front-panel display

Inspect the power supply as often as operating conditions require.

To clean the exterior surface:

1. Remove loose dust on the outside of the power supply with a lint-free cloth. Be careful that you do not scratch the display.
2. Use a soft cloth dampened with water to clean the power supply. Use an aqueous solution of 75 percent isopropyl alcohol for a more efficient cleaning.

⚠ CAUTION

To avoid damage to the surface of the power supply, you should not use any abrasive or chemical cleaning agents.

Specifications are subject to change without notice.
All Keithley trademarks and trade names are the property of Keithley Instruments.
All other trademarks and trade names are the property of their respective companies.

Keithley Instruments
Corporate Headquarters • 28775 Aurora Road • Cleveland, Ohio 44139 • 440-248-0400 • Fax: 440-248-6168 • 1-888-KEITHLEY • www.keithley.com



A Greater Measure of Confidence